

MAINE EROSION AND SEDIMENT CONTROL BEST MANAGEMENT PRACTICES (BMPs)

Manual for Designers and Engineers

October 2016



MAINE DEPARTMENT OF ENVIRONMENTAL PROTECTION
17 State House Station | Augusta, Maine 04333-0017
www.maine.gov/dep

ACKNOWLEDGEMENTS

Production:

2016 Revision: Marianne Hubert, Senior Environmental Engineer, Division of Environmental Assessment, Bureau of Water Quality, Maine Department of Environmental Protection (DEP).

Illustrations:

Photos were obtained from SJR Engineering Inc., Shaw Brothers Construction Inc., Bar Mills Ecological, Maine Department of Transportation (DOT), Maine Land Use Planning Commission (LUPC) and Maine DEP.

Technical Review:

The following people participated in the revision of this manual:

Steve Roberge, SJR Engineering, Inc., Augusta
Ross Cudlitz, Engineering Assistance & Design, Inc., Yarmouth
Susan Shaller, Bar Mills Ecological, Buxton
David Roque, Department of Agriculture, Conservation & Forestry
Peter Newkirk, Maine DOT
Bob Berry, Main-Land Development Consultants
Daniel Shaw, Shaw Brothers Construction
Peter Hanrahan, E.J. Prescott
William Noble, William Laflamme, David Waddell, Kenneth Libbey, Ben Viola, Jared Woolston, and Kerem Gungor of the Maine DEP

Revision (2003):

The manual was revised and reorganized with illustrations (original manual, Salix, Applied Earthcare and Ross Cudlitz, Engineering Assistance & Design, Inc.).

Original (1991):

The original document was funded from a US Environmental Protection Agency Federal Clean Water Act grant to the Maine Department of Environmental Protection, Non-Point Source Pollution Program and developed under contract by the Cumberland County Soil and Water Conservation District.

TABLE OF CONTENTS

INTRODUCTION	1
THE EROSION AND SEDIMENT CONTROL PLAN	3
A. SITE DEVELOPMENT	6
1. DUST CONTROL	7
2. CONSTRUCTION ENTRANCE / EXIT	8
3. OVERWINTER CONSTRUCTION	9
4. WATER DIVERSION	11
5. EXCAVATION DEWATERING	13
6. CONCRETE WASHOUTS	14
7. STOCKPILES	15
8. DEWATERING AND OFFSITE DISPOSAL	16
9. TEMPORARY ROADS AND LAYDOWN YARDS	18
B. SEDIMENT CONTROLS	21
1. SILT FENCE	23
2. EROSION CONTROL MIX BERM	24
3. FILTER SOCKS	25
4. STONE CHECK DAMS	26
5. STORM DRAIN INLET PROTECTION	27
6. HAY BALES	28
C. SEDIMENT CONTAINMENT	29
1. SEDIMENT TRAPS	30
2. SEDIMENT BASINS	31
3. GEOTEXTILE FILTER BAG	38
4. FLOCCULANTS (POLYMERS)	39
D. MULCHING	40
1. HAY/STRAW MULCH	42
2. EROSION CONTROL BLANKETS	43
3. EROSION CONTROL MIX	45
4. HYDRAULIC MULCH	46
E. VEGETATION	47
1. TOPSOIL	49
2. SEEDBED PREPARATION	50

3.	VEGETATION APPLICATION	51
4.	SODDING.....	53
5.	HYDROSEEDING	54
F.	SLOPES	55
1.	CUTS AND FILLS	57
2.	GEOTEXTILES	58
3.	RIPRAP PROTECTION	59
4.	GABIONS.....	62
5.	TURF-REINFORCED MATTING (TRM).....	64
6.	CELLULAR CONFINEMENT SYSTEMS.....	65
7.	SLOPE DRAINS.....	66
G.	SWALES AND DITCHES	68
1.	VEGETATED CHANNELS.....	70
2.	RIPRAP CHANNEL.....	72
3.	TURF REINFORCEMENT MAT.....	74
4.	LEVEL SPREADERS.....	75
H.	CROSS CULVERTS.....	77
1.	PIPE INLET PROTECTION	79
2.	PIPE OUTLET PROTECTION	80
I.	ROADS.....	82
1.	GRAVEL ROADS.....	83
2.	DITCH TURNOUTS	84
3.	FRENCH DRAINS AND ROCK SANDWICHES	86
J.	STREAM CROSSINGS	87
1.	CULVERT CROSSINGS.....	88
2.	TEMPORARY STREAM DIVERSION	91
3.	IN-WATER WORK	94
4.	TEMPORARY STREAM CROSSINGS.....	95
K.	SITE SPECIFIC BMPs.....	98
1.	SLOPE AND SHORELINE STABILIZATION.....	99
2.	BUFFERS.....	102
3.	STREAM BIOENGINEERING.....	105
4.	SAND DUNE AND TIDAL BANK RESTORATION	107
5.	GRAVEL PIT RECLAMATION.....	113

APPENDIX A. EROSION AND SEDIMENT CONTROL LAWS114

APPENDIX B. MAINE DEPARTMENT OF TRANSPORTATION - STANDARD
SPECIFICATIONS116

APPENDIX C. HYDROLOGIC SOIL GROUPS AND SOIL INFORMATION117

APPENDIX D. INSPECTION CHECKLIST, FREQUENCY AND REPORTING FORM122

INTRODUCTION

Contaminants, nutrients such as phosphorus, attached to soil particles contribute to “non-point source pollution”. The environmental impact of erosion and sedimentation can be irreparable; and planning for and preventing erosion in the first place can be less costly than labor intensive repairs later. The purpose of this handbook is to help land developers, consultants, and contractors use the appropriate erosion and sedimentation control Best Management Practices (BMPs) for the site and conditions whenever disturbing soil or removing a natural ground cover.

Large-scale development areas exposed to erosion during construction have the greatest potential for significant sedimentation of a resource. But, a small discharge of turbid water from a simple residential lot development can also have damaging effects.

WHAT ARE EROSION AND SEDIMENTATION?

Soil erosion is the detachment of soil particles and loss of surficial soil by the actions of water, ice, gravity, or wind. Water-generated erosion causes the most severe damage to a site under development. Sedimentation is the consequence of erosion when the eroded soil particles are deposited in a new location.

HOW DOES EROSION OCCUR?

Because the rate of erosion compounds exponentially, it is vital to control its initial stages.

- **Raindrop erosion** occurs when rain falls and dislodges individual soil particles from an unprotected soil surface. These particles can be easily picked up and transported great distances by stormwater runoff.
- **Sheet erosion** occurs when the runoff removes a whole layer of an unprotected soil surface.
- **Rill and gully erosion** occurs as the runoff concentrates in rivulets and cuts into the soil surface. When not repaired, the rills develop into larger gullies.
- **Stream and channel erosion** occurs as the increased volume and velocity of the runoff reaches a stream or waterway and cuts away at the banks of the channel.

OTHER FACTORS LINKED TO EROSION

Erosion potential is directly related to the soil's capacity to hold and transfer water such as:

- Soils with good structure are less prone to erosion; but soil compaction like soil disturbance may destroy the soil structure, and increase erosion and runoff potential. A soil with high amounts of silt or very fine sand is more erodible than a soil with a higher percentage of clay or organic matter. Well-drained and well-graded gravels with little or no silt are the least erodible soils.
- A ground surface that is well vegetated is shielded from the impact of falling rain and will resist the velocity of runoff. Also, the root systems hold the soil particles and aid in absorbing water. Pavement or a gravel base is also considered a proper cover.
- Slope length and gradient will determine the velocity of the runoff and the extent of erosion. Steep and/or long slopes are the most subject to erosion.
- The intensity and duration of a rainfall event determines the volume and velocity of runoff and therefore its energy in detaching and transporting soil particles. Intense and long duration rainfall events cause the most severe erosion.

THE EROSION CONTROL LAW

The Erosion and Sedimentation Control Law (Title 38 M.R.S.A. Section 420-C) applies to all activities in Maine's organized territories that will cause the filling, displacement or exposure of all earthen materials. The Erosion and Sedimentation Control Law requires that appropriate measures prevent unreasonable soil erosion and sedimentation beyond the site or into a protected natural resource (such as a river, stream, brook, lake, pond, or wetland). Erosion control measures must be installed before the activity begins, and must be maintained until the site is permanently stabilized. The Erosion and Sedimentation Control law and other laws that pertain to construction in the state of Maine are presented in Appendix A.

The primary purposes of these laws are to:

- Promote pre-planning with an erosion control plan to prepare for unforeseen conditions.
- Install erosion and sediment control practices before construction begins to prevent unreasonable erosion and sedimentation that may require additional construction time and cost to repair, and to maintain these practices to ensure that they remain functional until the site is permanently stabilized.
- Control erosion and sedimentation at any construction sites with the consequence that unreasonable erosion and sedimentation can lead to additional construction costs, fines and the possible revocation of a permit.

THE EROSION AND SEDIMENT CONTROL PLAN

All projects permitted through the DEP need an erosion and sediment control (ESC) plan; but proper planning is also important for all other projects, and especially if located in an area at risk of eroding and causing sedimentation. The ESC plan should be prepared during the design phase and before construction begins; and the contractor should understand the plan, implement it in a timely manner, and adjust the measures as site or weather conditions change. The ESC plan only establishes the minimum required measures. The plan consists of three parts:

1. Description:

- Existing conditions and the proposed activities, site conditions (soils, topography, vegetation, property lines, buildings, etc.), and adjacent protected natural resources (i.e. coastal sand dune systems, coastal wetlands, significant wildlife habitat, fragile mountain areas, freshwater wetlands, community public water system primary protection areas, great ponds, and rivers, streams or brooks).
- Areas that are subject to serious erosion problems.
- Measures that will be used to control erosion and sedimentation, where they will be installed and when needed.
- Construction schedule and planned inspections with frequency and required maintenance.

2. Site Plans:

- Topographic land contours and drainage before and after construction.
- The limits of vegetation clearing and grading.
- Any vegetated buffers that should be protected.
- Sensitive areas within 100 feet of the site (streams, lakes, wetlands or areas sensitive to erosion).
- Drainage swales, ditches, roads, and stormwater control structures.
- The location and types of ESC measures.

3. Construction Details:

- Plans and specifications of ESC structures.
- Amount, type, and installation details for seeding, mulching and other vegetative specifications.
- All pertinent maintenance instructions.
- Schedule for stabilization and revegetation including overwinter stabilization measures if the work extends into the winter construction period (see *Overwinter Construction*).

IMPORTANT NOTE:

Consider and plan for unforeseen conditions, weather and delays that may affect the construction schedule and BMP performance. Will grading be completed before winter? Will all measures be effective during each phase of the project?

THE SIMPLE ESC PLAN!

Use this simple ESC plan for small sites (houselots)

S = Stabilize disturbed soils before moving on!

I = Install sediment barriers before construction!

M = Mulch daily!

P = Protect natural buffers!

L = Limit the area of soil disturbance!

E = Evaluate and repair all ESC measures!

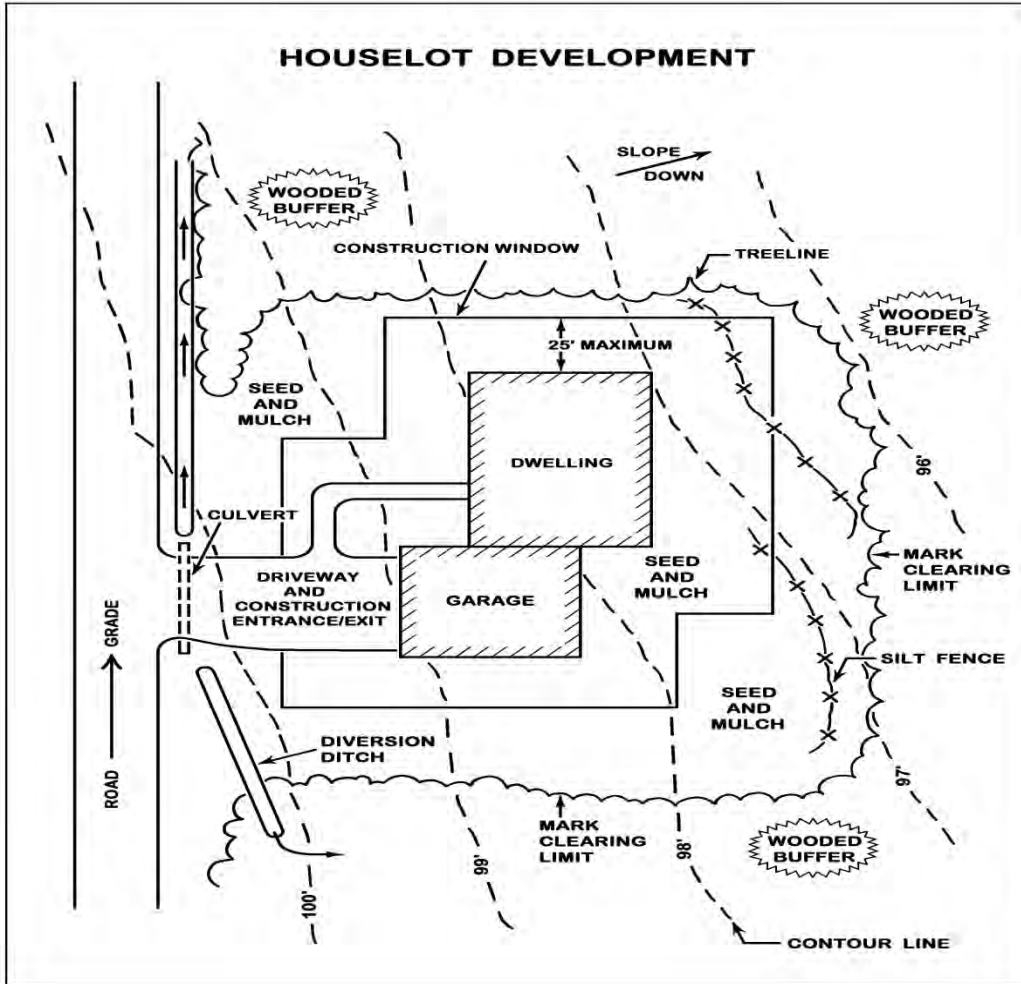

CONSTRUCTION INSPECTION REQUIREMENTS AND TRACKING

Anyone who is actively involved in exposing, filling or displacing soil or other earthen materials must take appropriate measures to prevent erosion and the loss of sediment beyond the project site or into a sensitive resource.

Any soil disturbance should be inspected regularly (a minimum of once a week, and before and after a storm event) until the site is fully stabilized with either 90% grass cover or a permanent impervious surface by a person who has the knowledge of ESC measures and the understanding of stormwater management. Any failing measure should be repaired or adequately modified to stabilize the site prior to the next storm event but no later than 7 calendar days.

Appendix D provides an *Inspection Frequency Table* and an *Inspection Tracking Form* which may be used or adapted to schedule inspections, record findings and plan for necessary maintenance tasks. Photos are helpful!

SMART DEVELOPMENT STRATEGY DO IT RIGHT THE FIRST TIME!		
Plan the development to fit the site	Unnecessary grading should be avoided	<ul style="list-style-type: none"> • Develop the least critical areas of the site and avoid development near natural resources. • Protect existing native vegetation and the natural forest floor.
Minimize the area of exposed soil at one time	Exposed soils are sources of erosion	<ul style="list-style-type: none"> • Build a large development project in small phases. • Protect buffer strips between construction activities and natural resources. • Immediately seed and mulch areas ready for revegetation.
Stabilize cut and fill slopes	Disturbed slopes are vulnerable to unchecked runoff.	<ul style="list-style-type: none"> • Divert and disperse clean runoff to a stable area. • Anchor mulch over seeded area, or use structural materials (riprap, gabions, revetments or retaining walls, etc.)
Be mindful of the protected natural resources	Sedimentation of natural resources should be avoided.	<ul style="list-style-type: none"> • Use precautions when adjacent to a protected natural resource or on long steep slopes. • Immediately stabilize all channels or constructed slopes greater than 8%. • Use overwinter practices from Oct. 15 to April 15. • Mulch any soils that will be exposed for longer than 15 days.
Use special measures at stream crossings	Construction projects in or adjacent to streams can harm aquatic life.	<ul style="list-style-type: none"> • Install culverts quickly and during low stream flow (late summer). • Minimize soil disturbance adjacent to streams. • Consult with the Maine Department of Inland Fisheries and Wildlife (MDIFW) regarding in-stream activities between July 14 and Oct. 2.
Prevent sediment from reaching stormwater discharge points	Runoff should not discharge offsite or to a protected natural resource	<ul style="list-style-type: none"> • Avoid channelizing runoff • Install filter barriers around catch basin inlets and culverts. • Protect larger culverts with stone check dams and sediment traps. • Use temporary sediment basins during construction.
Avoid mud and dust in public roadways	Mud makes roads slippery and is a nuisance when it is dry (dust).	<ul style="list-style-type: none"> • Install gravel pads at the construction site entrance/exit(s). • Use water as dust suppression. • Sweep public roads.
Inspect ESC measures and adjust, maintain or repair	ESC measure should be inspected regularly by a designated and knowledgeable person.	<ul style="list-style-type: none"> • Prescribe frequency of inspections (once a week, before and after every storm). • Inspect regularly and maintain all ESC measures. • Follow-up with an inspection report to owner, design engineer, and town.
Remove temporary ESC measures	Temporary ESC measures are unnecessary when the site is stable.	<ul style="list-style-type: none"> • ESC measures need to be removed when the site is stable.

A. SITE DEVELOPMENT

Considerations of the existing site conditions, and phasing the construction and development will reduce site vulnerability to uncontrolled erosion and sedimentation. It will save both time and money! The potential for erosion is related to the type of soil, the presence of water and the slope's length and steepness.

IMPORTANT NOTES:

Beware of site development hidden costs! Phasing and installing effective passive erosion control measures will be less costly and simpler to manage than having to provide structural sedimentation measures in concentrated flows or for large volume of water.

Appropriate ESC protection is necessary for steep slopes, erodible soils or where surface water or groundwater makes permanent stabilization difficult. Sites in loamy soils are more erodible than sandy or clayey soils.



1. DUST CONTROL

Dusty conditions occur when a disturbed site or road surface has dried out; and dust from wind erosion becomes an environmental or public concern. Note that a gravel surface without fines results in washboarding.

Stabilize all laydown areas and all unpaved surfaces with a base gravel or coarse gravel as soon as possible. Use traffic control to restrict speed and route.

Water Application with frequent reapplication during warm sunny days will mitigate dust. The distribution of water should not cause turbid runoff.

Sweep and Vacuum paved road surface when dry. Sweep from the centerline to the edge of the travel way. Do not sweep into a waterbody or wetland. The public roadway may also require sweeping.

Calcium Chloride applications are more cost-effective on larger sites (30% calcium chloride is recommended for most gravel surfaces or follow the supplier's guidance).

Soil Binders may require pre-wetting, a 24-hour curing time and minimum temperatures for use. Asphalt or oil-based binders are not allowed.



2. CONSTRUCTION ENTRANCE / EXIT

A pad of coarse aggregate at the construction entrance/exit will reduce the tracking of soil from construction traffic onto a public street. Sediments from the tire treads are knocked loose by the angular stones and are trapped in the voids between the stones.

COMPANION BMPs: Sediment Traps, Sediment Controls

CONSTRUCTION SPECIFICATIONS

- The entrance/exit pad should have a length of 50 feet or more and a 12-foot minimum width (or as appropriate to contain the wheel base of construction vehicles plus 3 feet on either side).
- The pad should be 6 inches or more thick with angular aggregate (2-3 inch diameter). Appropriate reclaimed concrete material may be used.
- The aggregate should be placed over a geotextile filter to prevent the stones from pushing into the native soil.
- At the bottom of slopes, a diversion ridge should be provided to intercept runoff.
- Berms may be necessary to divert water around any exposed soil, and runoff should be directed to a sediment trap.
- The wheels of construction equipment may be washed prior to exiting the site. Washing should be performed in an area that drains to a sediment trap or basin.
- The pad should be inspected weekly, and before and after each storm. The pad may have to be replaced if the voids become filled with sediment. Street sweeping may be necessary.

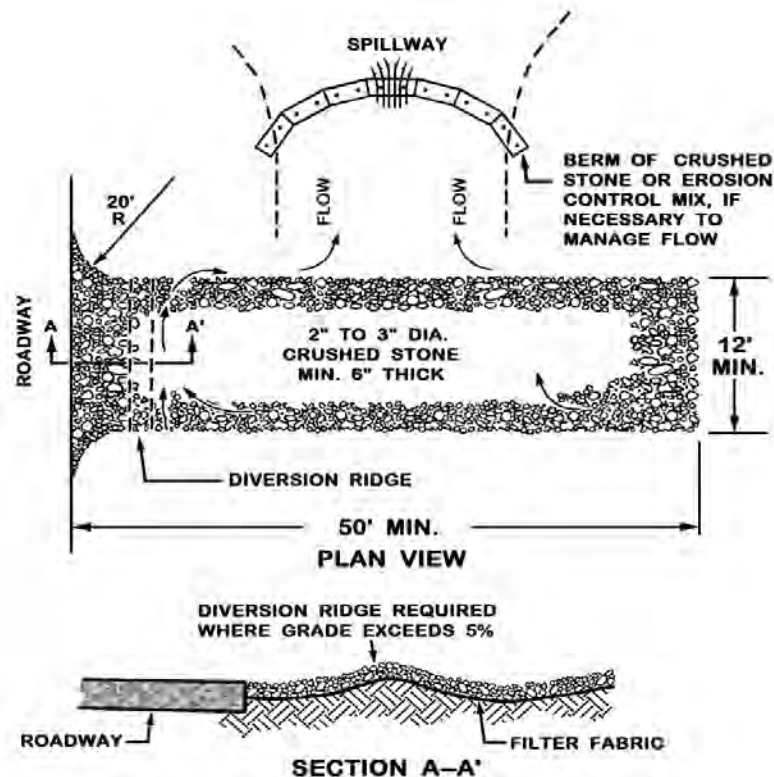

3. OVERWINTER CONSTRUCTION

The winter construction period runs from November 1st through April 15th; however no vegetation growth should be anticipated past October 15th in southern Maine and even earlier in the northern areas. Additional stabilization measures should be provided by November 1st for winter and spring snowmelt if a construction site is not permanently stabilized with pavement, a gravel road base, 90% mature vegetation cover, erosion control mulch, or riprap. Ideally, permanent seeding should occur 45 days before the first killing frost (different dates for different Maine locations); otherwise, overwinter mulching is necessary. *See the Vegetation section for more information.*

With the changing climatic conditions seen in recent years, more variability has been observed in the start and end of winter conditions; however, understanding that vegetation will no longer grow past October 15th and that full erosion control measures should be provided for full overwinter conditions is still the safest approach.

COMPANIONS: Mulching, Sediment Traps, Vegetation, and Slopes

Overwinter Construction Difficulties	
Increased precipitation with no vegetation uptake or evaporation	More surface runoff that can be directed to erosion control measures.
Frozen Grounds	The soil loses its capacity to retain water and cause more surface runoff and potential erosion.
Vegetative Ground Cover	Cannot be established outside of growing season.
Runoff Diversion	Snow or icing may clog diversion structures.
Sedimentation Basins	Should be installed before the ground is frozen. Can be overwhelmed by spring flows.
Silt Fence	Difficult to install on frozen ground. Often fails during spring melt.
Erosion Control Blankets	Cannot be anchored on frozen ground.
Hydro-seeding	Stabilizers are ineffective in cold temperatures.
Vegetated Swales	Cannot be established outside of growing season.
Impervious Stabilization	Base gravel on driving/parking areas. Pavement cannot be installed in winter.
'Mud' Season	Spring thaw

Overwinter Hay Mulch should be applied at double the normal rate (150 pounds per 1000 square feet or 3 tons/acre) and should be anchored with netting (peg and twine) or a tackifier to prevent mulch displacement before freezing conditions. No soil should be visible through the mulch. Hay mulch cannot be applied over snow.

Dormant Seeding and Mulch should be applied at 3 times the specified amount after the first killing frost. All dormant seeding beds should be covered with overwinter mulch or an anchored erosion control blanket.

Temporary vegetation should be applied by October 1st (to prepare for winter conditions) with winter rye at 3 pounds per 1000 square feet, and mulched with anchored hay at 75 pounds per 1000 square feet or with erosion control blanket. If the rye fails to grow at least three inches and have 75% coverage by November 1st, the area should be stabilized for overwinter protection.

Erosion control mix is the best overwinter cover, but is not recommended for slopes steeper than 1:1 or in areas with flowing water.

Erosion Control Blankets should be used on slopes where hay would be disturbed by wind or water. The matting should be installed, anchored and stapled in accordance with the manufacturer's

recommendations. Full contact between the blanket and the soil is critical for an effective erosion control cover.

Riprap should be properly sized and installed to ensure long-term stability. In the winter, newly constructed ditches and channels should be stabilized with riprap. Widening of the channel may be required to accommodate the placement of stones. Angular riprap is preferred to round stone (tailings).

Sod may be used for late-season stabilization (after October 1st), but it is not recommended for slopes steeper than 3:1 or in areas with groundwater seeps. Follow the supplier's instructions.

ENGINEERING DESIGN

- If construction occurs after **November 1st**, all disturbed areas should be stabilized daily if the construction is active. Any erosion or discharges should be repaired immediately.
- No more than 1 acre should be actively worked on at any one time without regular inspection; or the exposed area should be limited to which can be mulched in one day. Any measures necessary to control erosion/sedimentation should be installed for the conditions at the site (soil erodibility, slope, groundwater, size, weather conditions, etc.).
- For over-winter protection, a **double row of sediment barriers** (silt fence backed with hay bales or erosion control mix, etc.) should be placed within 75 feet of a protected natural resource.
- All **hay mulch** should be anchored with netting, asphalt emulsion chemicals, tracking or erosion control mix after November 1st. The ground surface should be invisible under the mulch.
- **Loam or seed** is not effective after October 15. Finished areas can be mulched without seeding or with dormant seeding applied at a 3 times the specified rate for permanent seeding. All areas seeded during the winter should be inspected in the spring and revegetated if the catch is less than 75 %.
- All vegetated **areas with a slope of 15% or less** should have 90% grass cover by November 1st or should be seeded with winter rye at a seeding rate of 3 pounds per 1000 square feet, mulched with hay at 75 pounds per 1000 square feet, and anchored with netting. Or, by November 15, the area should be protected with an erosion control blanket, erosion control mix, or with hay at a rate of at least 150 pounds per 1000 square feet.
- All vegetated **slopes greater than 15%** should be seeded and mulched by September 1. If a slope is not stabilized by October 15, the soil may be seeded with winter rye at a seeding rate of 3 pounds per 1000 square feet and protected with erosion control blankets. If the rye fails to grow three inches or fails to cover at least 75% of the slope by November 15, the slope should be protected with an erosion control blanket, erosion control mix, or riprap.
- All **grass-lined ditches and channels** should be constructed and stabilized by September 1. If a ditch or channel is not sufficiently grassed over (75% cover) by November 15th, the ditch should be lined with stone riprap. The ditch will need to be over-excavated to accommodate the thickness of the riprap.
- **Soil stockpiles** should be mulched for over winter protection with hay at twice the normal rate or with a four-inch layer of erosion control mix. Stockpiles should not be left overwinter (even mulched) if within 100 feet from a protected resource.

4. WATER DIVERSION

A water diversion consists of a channel constructed across or above a work site to direct runoff away from a disturbed area to a stable discharge point that is unlikely to erode. It can either be an excavated ditch that intercepts groundwater and surface water, or a berm that diverts surface runoff. A permit may be required for dewatering a wetland or waterbody in accordance with Maine Natural Resource Protection Act (NRPA). For additional information please contact your nearest DEP regional office.

COMPANION BMPs: Riprap, Mulching, Sediment Traps, and Vegetation

ENGINEERING DESIGN

- Construction plans should incorporate the **location of temporary water diversions** intended to divert clean water around the construction and of necessary diversions within the construction area. Diversions should not substitute terracing or land grading.
- **Permanent diversions** should be permanently stabilized and have the capacity for the peak runoff rate from a 10-year storm with a berm width of 3 feet or more and a height sufficient to contain the discharge.
- **Water management** needs to start at the onset of construction. During the clearing phase of the project, large equipment will need to access the site resulting in significant disturbance, soil compaction, and rutting. This disturbance and control of erosion is the first step in the construction process and provides a critical opportunity to establish solid stormwater management practices from inception.
- For high sediment-producing areas, the diversion should be directed to a **sediment trap**.

CONSTRUCTION SPECIFICATIONS

- The condition of the site topography, land use, soil type and length of slope should determine the location of a diversion.
- The diversion should be angled away from the slope (with a 2-3% downward gradient) for positive drainage to a stable discharge point (plunge pool, level spreader or energy dissipater).
- Diversions designed to protect buildings and roads should have the capacity to manage the runoff from a large storm event.
- Diversions should not be used below high sediment-producing areas unless maintained and monitored daily.
- Exposed soils should be shaped, graded, and stabilized immediately unless a diversion will be provided to direct any runoff to a temporary sedimentation structure.
- All diversion dikes and berms should be compacted and stabilized with material that is appropriate for the slope and expected runoff (erosion control blankets, gravel or riprap).
- A diversion berm should be wide and the dike deep enough to allow for maintenance access as well as contain the volume of runoff.
- Any gullies or depressions crossed by the diversion should be filled, compacted, and stabilized.
- On long slopes, multiple diversions will manage smaller volumes of runoff and be less likely to fail.



A temporary diversion structure is most important during a storm event and until the area is revegetated and stable. It should always be kept clear of sediment and debris.



A vegetated diversion needs to be stabilized early during the growing season (prior to September 1st) for full vegetative cover before winter. Upon final stabilization, a temporary diversion should be restored to the intended grade.

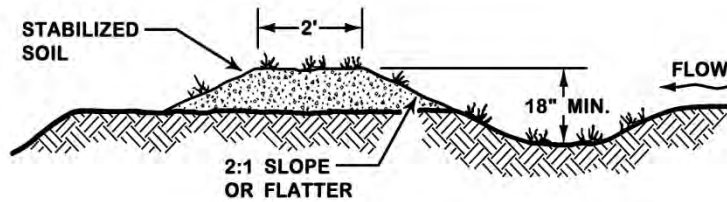

DIVERSION WITH EXCAVATION

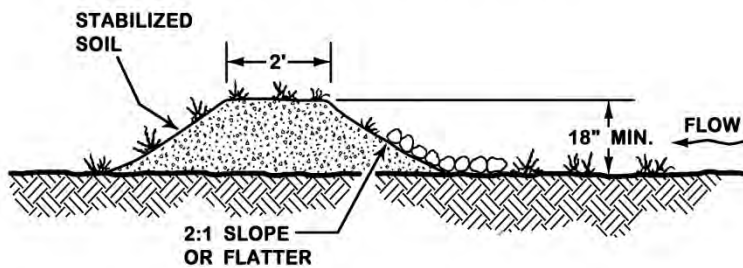

DIVERSION WITH FILL

5. EXCAVATION DEWATERING

Dewatering occurs in 3 phases: removing the water from the excavation area (gravity drain, mechanical pumping, siphoning or using the bucket of construction equipment); providing settlement from the collected water (sediment basin or trap, bag, etc.); and providing a stable discharge point.

COMPANIONS: *Sediment Traps, Vegetation, and Slopes*

CONSTRUCTION SPECIFICATIONS

- The discharge to the sediment treatment area should never exceed its capacity.
- Divert upgradient clean runoff away from an excavated area.
- Avoid discharging to an unstable area, newly vegetated or within 100 feet of a natural resource.
- A positive displacement pump is recommended when pumping is necessary and the water contains a lot of sediment.
- The elevation of the pump above the water intake and the distance of the discharge hose will greatly affect its pumping capacity.
- Any channel dug for discharging water should be stabilized with ditch lining (riprap, geotextile fabric, plastic sheeting, etc.).
- Limit the length of a trench excavation to 500 feet at any one time (the excavated material should be placed upgradient of the trench).
- If the collected runoff is contaminated with oil, grease, or other petroleum products, filtering through an oil/water separator or a filtration mechanism is recommended. The DEP should be contacted for any significant known spill or unknown source of contaminant.



The water removed from the excavation area should either be discharged as sheet flow to a buffer area or to a treatment structure. During dewatering, frequently inspect the receiving area for signs of erosion, concentrated flows or sediment discharge and repair immediately. Avoid working in periods of intense, heavy rain.

6. CONCRETE WASHOUTS

Concrete wash water is alkaline and can contaminate groundwater or surface water. A containment structure should be provided to retain, collect, and solidify concrete before it can clog a drainage channel or structure. Concrete washouts are designed to promote the hardening of the concrete and evaporation of excess liquids.

CONSTRUCTION SPECIFICATIONS

- A concrete washout station should be sized to handle all the wash water, solids and rainfall without overflowing. Typically, 7 gallons of water are required to clean a truck chute and 50 gallons for the hopper of a concrete truck.
- A below-grade washout should be sized to contain all liquid wastes with a 4-inch freeboard.
- Access to the washout pit should be stable and secure (i.e. base of gravel or crushed rock).
- A washout facility should not be placed within 50 feet of a storm drain or discharge point unless the pit is lined with anchored plastic sheeting (minimum 10-mil thickness) and is not allowed to overflow.
- Inspect the structure on a daily basis to assess usage and identify leaks and breaches. Dispose of the solids appropriately.



7. STOCKPILES

Stockpiled soils should be covered with an erosion control cover, and a sediment barrier should be installed along their downgradient edge to collect runoff and sediments. In some situations, plastic sheeting or other material such as woven or non-woven geotextile fabric may be used to cover stockpiles. Plastic sheeting should be polyethylene with a minimum thickness of 4 mils.

CONSTRUCTION SPECIFICATIONS

- The soil surface should be smooth and free of protruding rocks and debris to prevent punctures of a fabric cover.
- A fabric cover should be provided with 12 to 24-inch overlaps in the direction of runoff.
- Anchoring should be continuous along each side of the pile. On the windy side, additional anchors should be provided to maintain soil coverage and to prevent ballooning or blowouts.
- Topsoil from an agricultural source may be high in nitrogen and phosphorus. Special care should be taken with a secure cover if stockpiled upslope from a protected natural resource.
- Inspect regularly and before, during and after any major rain event and repair as necessary.



8. DEWATERING AND OFFSITE DISPOSAL

Some construction sites are composed of mostly fine soil particles that are difficult to remove once suspended in runoff (they easily pass through sediment barriers, or may require days of residency time in a pond to settle). Standard BMPs will not remove enough of the turbidity and pollutant load in the runoff before reaching the receiving waterbody, and the collection and disposal of that runoff to an off-site location may become necessary. Appropriate disposal locations could include gravel pits, high permeability fields with a natural depression and a healthy vegetated cover, or an existing settling pond. Because of cost and management difficulties, off-site disposal is often used as a last resort effort:

- Where sedimentation will degrade the downgradient resource,
- Common BMPs will not effectively trap the suspended silts or clays,
- The area of exposed soil is very large and the amount of turbid runoff that is generated is unmanageable, and
- A long-term settling or filtering device is not available.

Additional information about dewatering can also be found in Section A-5: Excavation Dewatering of this manual.

Off-site Disposal at Gravel Pits: While a generally accepted discharge location, many gravel pits are located over an aquifer that is a significant drinking water source, and that is at risk from contamination. Caution should be taken before discharging contaminated water in that area.

Off-site Disposal at a Water Quality Device or Pond: An underutilized sedimentation pond, “farm” / retention pond or other form of stormwater management device may provide sufficient settlement time (small basins may not have enough residency settling time); and it should not have a direct connection to a sensitive resource. Sediment accumulation may reduce the long-term effectiveness of the structure and will require maintenance at the end of the project.

Off-site Disposal at a Meadow Field with High Permeability: Some fields with highly permeable soils may infiltrate the discharge from an off-site turbid source. The field should preferably be concave (with no discharge point) or with a maximized flow path length that is greater than 200 feet. A level spreader (a berm of ECM or row of hay bales) should spread the discharge into sheet flow; but if rill erosion is observed after 150 feet of treatment length, the flow regime has been exceeded, a second level spreader can be provided midway of the treatment area.

ENGINEERING DESIGN

- Determine if all appropriate erosion controls have been considered before looking for an off-site disposal solution. Runoff diversions, a temporary cover (mulching, plastic sheeting, erosion control mix, etc.), proper site planning, and phasing may all reduce the generation of turbid runoff. Products like polymers/flocculants/soil binders may reduce the runoff turbidity if applied at the appropriate rates for the soil type.
- The types of high permeability soils that are appropriate for the disposal of turbid runoff may also indicate a protected aquifer under the site. The runoff should be tested prior to starting the discharge to identify the particle size distribution, nutrients, pollutants, and chemical composition (ph., PAHs, etc.).
- Determine if disposal is allowed at the selected location as many gravel pits and stormwater basins are regulated by both state and local agencies. Any location (stormwater sediment pond, field or gravel pit) that is considered should be investigated by a geotechnical engineer or hydrogeologist. All requirements of federal, state and local regulations must be met.
- Discharge into a private or municipal storm sewer may be viable if the storm sewer owner provides a letter of acceptance.

CONSTRUCTION SPECIFICATIONS (at the construction site)

- A stable water diversion system needs to be constructed within the construction site to intercept runoff, and to direct it to an appropriate pumping location. The use of plastic sheeting or impervious liners may be considered for storage and conveyance.
- A temporary sediment pond or storage tanks may be used for on-site storage. The frequency and intensity of rainfall events, and travel time to the disposal site need to be considered when providing on-site storage and number of trucks. Back up equipment should be available for emergencies.
- Truck turnaround time and distance must be considered before selecting a location for disposal.

CONSTRUCTION SPECIFICATIONS (at the receiving site)

- The loading rate of the discharge should never be faster than the infiltration capacity of the soil of the receiving site.
- To maximize infiltration at the receiving area, discharge should not occur during a storm event or if its capacity is at risk of being exceeded.
- The receiving site needs to contain all discharged turbid water without any outflow to a natural resource. Frozen soils may reduce the effectiveness of the infiltration.
- Eventually, the trapped sediments will clog a receiving area and will terminate its capacity to accept more turbid water. At the end of operations, it may be appropriate to rototill the top 6-12 inches of the receiving area to restore the soil's permeability, and a pond structure may be rehabilitated by excavating the accumulated sediment.

9. TEMPORARY ROADS AND LAYDOWN YARDS

Temporary construction access roads, linear projects (i.e. transmission line corridors, logging, etc.), or simply the preliminary construction of a permanent road can be a substantial source of erosion and sedimentation and should be specifically addressed during project planning and construction. These roads are typically composed of native soil, can change the site topography and can collect and direct concentrated stormwater toward a natural area insufficiently stable to receive an increase in runoff.

Also, before construction activities begin, tree clearing equipment often needs access to the site. These tree clearing activities will likely be working outside any existing access roads to clear trees and remove stumps or woody debris, and these activities may expose large areas of the construction site before any erosion control measures are installed. The duration of such activities can be from a few days to over a year.

Since temporary access roads and laydown yards are removed and the areas restored to as close to original grade as possible without changing the natural hydrology, these areas should be constructed with the minimum amount of material. Such areas may have a cover of native vegetation, organic duff, topsoil and/or the native mineral parent material soil, or they may be improved with a gravel surface that will need to be removed at the completion of the project. Temporary working areas can be protected with many measures, including the following:

- **Slash, logs, brush and wood chips.** Slash is defined as branches, bark, tops from trees and shrubs left on the ground as a result of logging, right-of-way construction or maintenance and land clearance. The Maine Forest Service can provide details on the Maine Slash Law (Title 12 M.R.S.A. §9331- 9338) and other regulations that must be complied with.
- **Articulated construction mats** from wood beams, rubber, metal, or wood composite, etc. Commonly mats used are made of 8-inch square timbers bolted together to make a mat that can range between 2 and 8 feet wide and 8 to 40 feet long.
- **Gravel base with culverts** over a geotextile fabric that will be removed at the end of the project. The geotextile fabric indicates the limit of fill removal.

IMPORTANT NOTES

- Laydown yards should never be located in a wetland, and any fill material (mats, logs, wood chips, gravel, etc.) for a wetland crossing will need to be removed, unless appropriately permitted by federal, state, and local agencies.
- Additional erosion control measures will be necessary when the site is active during the winter, and all measures should be adequate for anticipated precipitation and runoff events.
- Oxyaquic conditions (oxygenated groundwater) apply to sloping sites with hardpan soils and with a large contributing watershed. They are found at higher elevations, along the coast, and in the foothills. Oxygenated groundwater can travel very rapidly through the soil and may exit an exposed slope as a significant spring.



CONSTRUCTION MATS displace ground pressure of vehicles and create a barrier between the vehicle tires/tracks and the ground surface. Mats reduce soil damage, which can reduce the erosion potential, rutting and mixing of topsoil with subsoils. Mats also reduce vehicle rutting, which can carry stormwater long distances, and directly to natural resources. Modular construction mats can be used multiple times throughout the life of a project.

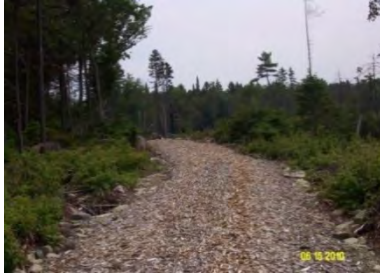

SLASH AND WOOD DEBRIS can be used on construction projects that require extensive tree clearing/removal by laying slash or chips as the temporary access areas. The woody material will reduce rutting by displacing equipment ground pressure and acts as an erosion control measure by covering the exposed soil.

ENGINEERING DESIGN

- Develop **stormwater management plans** that describe pre-development and post-development site conditions and the estimated effects of the temporary structures on site runoff, peak discharge rates, flooding, and water quality, etc. Identify stormwater and erosion and sediment control measures that will be required.
- The **delivery, installation and removal** of any temporary surface cover must minimize soil impacts.
- The conditions of the temporary areas will **need** to be monitored during the **spring runoff** or other periods of high groundwater table and/or excessive rain as they may become unstable, with deep ruts and excessive mud and turbid water.
- **Laydown yards** should be sited on flat or gently sloping convex areas that have moderately well drained soils or better to prevent a muddy working surface, rutting, soil erosion, sedimentation, and other environmental and operational problems.
- **Construction mats** should be placed perpendicular to the direction of travel. These should be removed within 30 days from the end of construction with the area restored to natural conditions (soil aerated, seeded and mulched).
- A layer of **wood chips or erosion control mix** can be used as a temporary road base if placed with a thickness of 3 to 4 inches. The material will need to be replenished as the layer decomposes and becomes less effective. The wood chips can absorb moisture and will eventually decompose sufficiently to support vegetation once usage of the road is terminated.
- **Slash and wood debris** can be used on construction projects that require extensive tree clearing/removal by laying slash or chips as the temporary access areas. The woody material will reduce rutting by displacing equipment ground pressure and acts as an erosion control measure by covering the exposed soil.
- Additional stabilization measures must be provided where a sloping site may have an **'oxyaquic' groundwater condition** (where the groundwater travels very rapidly through the soil), and the excavation exposes a confining layer where the water may exit as a significant spring.

CONSTRUCTION SPECIFICATIONS

- All land clearing activities are subject to erosion and stormwater control standards.
- Identify where soil disturbances will require the installation of erosion control measures, and establish the responsibility for the timing and maintenance of these measures.
- All applicable erosion control measures (silt fence, stone check dams, mulching, etc.) should be installed to reduce the amount of sediment reaching the resource and must be maintained for the duration of the project.
- A denuded site might need to be re-stabilized several times if the construction time exceeds the life of the stabilization method.

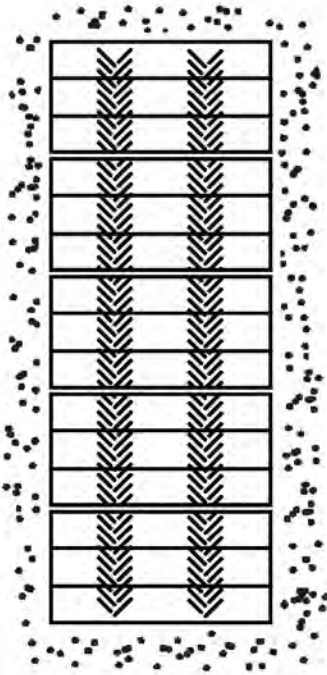

UNIFORM SURFACE

MATS ARE PLACED FLAT ON GROUND, PERPENDICULAR TO TRAFFIC. THE WIDTH OF DRIVING SURFACE IS LIMITED BY MAT LENGTH.

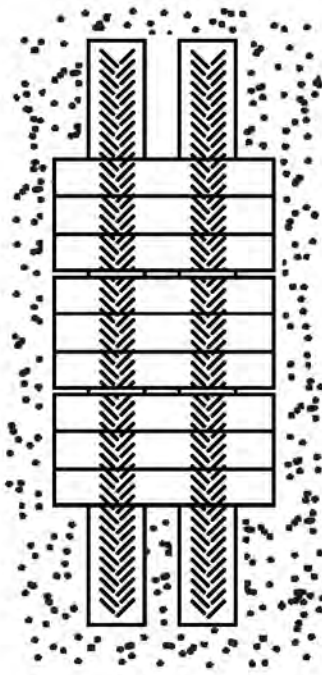

NON-UNIFORM SURFACE OR WEAK SOILS

STRINGERS ARE PLACED PARALLEL TO TRAFFIC TO BRIDGE ACROSS THE TERRAIN. DECKING IS PLACED ON TOP TO PROVIDE A SOLID ROAD SURFACE.

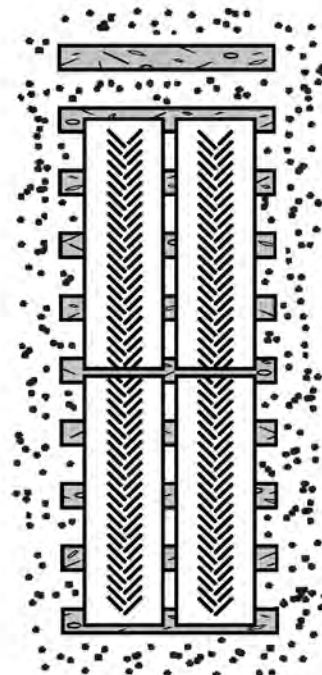

WETLANDS OR POOR DRAINAGE

BARs ARE PLACED PERPENDICULAR TO TRAFFIC TO COVER A LARGE AREA TO DISTRIBUTE WEIGHT. RUNNERS ARE SET OVER THE BARs, PARALLEL TO TRAFFIC.

B. SEDIMENT CONTROLS

Sediment barriers should be installed downgradient of all disturbed soils. There are many available types of sediment barriers provided they are installed, used, and maintained properly.

COMPANIONS: *Mulching, Vegetation, Riprap, Slopes, and Roads*

IMPORTANT NOTE

Sediment barriers reduce runoff velocity and allow for soil settlement. If water has a chance to concentrate and gain velocity, most sediment control barriers will fail. Water velocity is a critical element of erosion.

ENGINEERING DESIGN

- Sediment barriers should be designed for a contributing drainage area that is less than 1/4 acre per 100 feet of barrier or with a drainage distance of 100 feet or less.
- A diversion may be necessary on slopes steeper than 2:1.
- The barrier should extend uphill if there is evidence of **end flow**.
- Water impoundment exceeding 36 inches may cause failure of a **silt fence**.
- **Hay bales** should be replaced with another sediment barrier if needed for a period that is longer than 2 months.

CONSTRUCTION SPECIFICATIONS

- Sediment barriers must be installed prior to soil disturbance.
- All barriers should be installed on the land contour and each end curved uphill to prevent bypass (to an elevation higher than the top of the barrier).
- The runoff from the contributing area should not exceed the capacity of the barrier; or mid-slope barriers may be necessary. The drainage flow length should be no longer than 100 feet.
- Where possible, a level area immediately up-gradient of the barrier should be provided for ponding and absorption.



Two rows of sediment barriers (i.e. silt fence and a berm of erosion control mix) may be preferred for controlling sediment discharge near a natural resource, for large disturbances or on steep slopes of wet loose soils.



Sediment barriers should be inspected and repaired before, during, and after each rain event.



Collected sediments should be removed when one-half the height of the barrier is filled.



Silt fence can be difficult to install properly in shallow-to-ledge, stony, frozen, or forested soils.



Sediment barriers should be removed when the area is stabilized. The collected sediments should be leveled, seeded and mulched.



Any erosion downgradient or around the edges of a sediment barrier or check dam should be corrected immediately.



Damaged or otherwise ineffective sediment barriers should be replaced with new material or a different barrier measure.

1. SILT FENCE

Silt fence is a permeable geotextile fabric which intercepts overland runoff, reduces flow velocity, and promotes the settlement of sediments. The geotextile fabric will degrade due to sun exposure and its life span is approximately one field season. Pre-manufactured silt fencing with attached posts is used in most situations.

CONSTRUCTION SPECIFICATIONS

- The fence should be anchored to resist pull-out, and be stretched tightly between stakes to prevent sagging.
- A 6-inch wide and 6-inch deep trench should be excavated upgradient of the fence line to key the “flap” of the fabric. The trench is backfilled and compacted.
- When joints are necessary, filter cloth should be spliced by wrapping end stakes together.
- In areas where the flap cannot be keyed properly (due to frozen ground, bedrock, stony soil, roots, near a protected natural resource, etc.), the silt fence should be anchored with aggregate, crushed stone, erosion control mix, or other material.

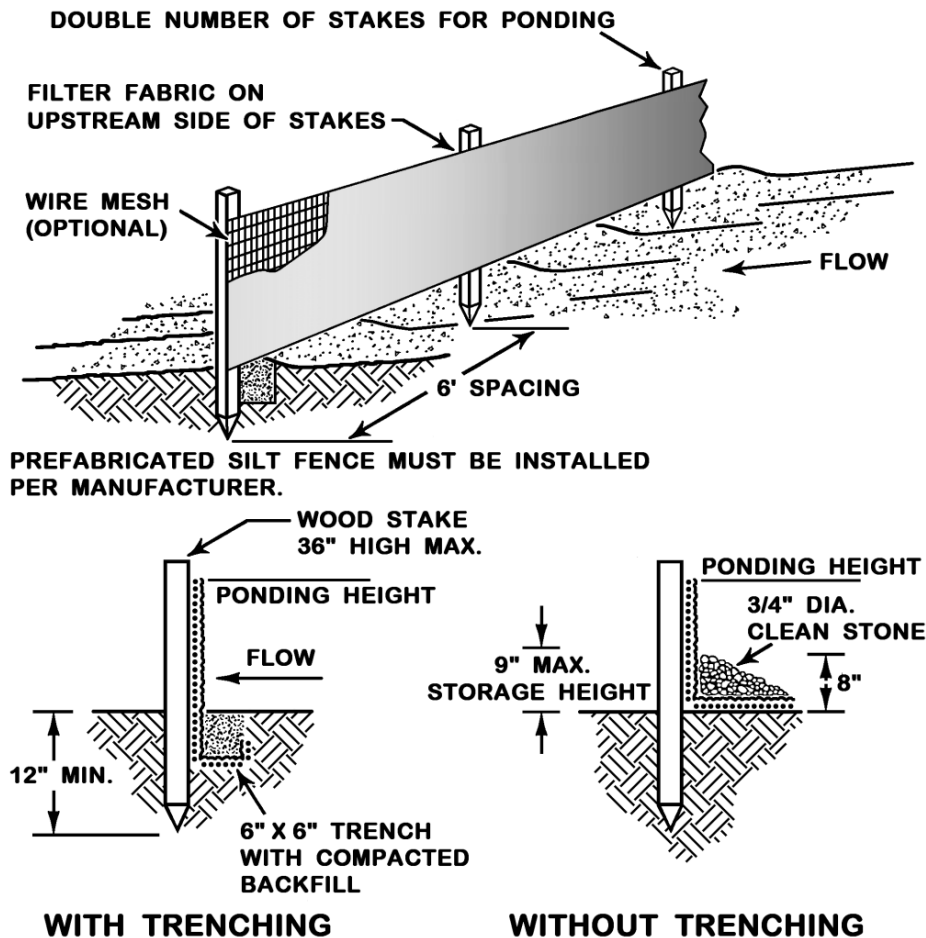

2. EROSION CONTROL MIX BERM

Berms of erosion control mix (ECM) are effective on frozen ground, outcrops of bedrock, and heavily rooted forested areas, or when other temporary erosion and sediment control measures are not practicable.

IMPORTANT NOTE:

A great source of erosion control mix is stump grindings. The soil within the root ball should not be removed before grinding as it adds structure to the media. See the Erosion Control Mix Mulch BMP section for material specifications.

CONSTRUCTION SPECIFICATIONS

- It may be necessary to cut, pack down or remove tall grasses, brush or woody vegetation to avoid voids and bridges that allow the washing away of fine soil particles.
- The ECM berm should be a minimum of 12" high and a minimum of two feet wide. On longer or steeper slopes, the berm will need to be wider and higher.
- Berms composed of ECM can be reshaped when necessary.



Depending upon the type of material, the berm may be placed by hand, machinery, or pneumatic blower.

3. FILTER SOCKS

A continuous contained berm or filter sock is a manufactured synthetic netting tube that is filled with erosion control mix, or other finely shredded organic material (i.e. coconut fiber or other). The netting prevents the displacement and loss of the organic filter material. Continuous contained berms work well in areas where trenching for a silt fence is not feasible, such as on frozen ground or over pavement. A filter sock can be reshaped (if a vehicle drives over it).

Seeds may be added to the filler material for a permanent vegetation cover. Various manufactured products are available and installation should follow the manufacturer's specifications.

CONSTRUCTION SPECIFICATIONS

- A filter sock is most effective use for small disturbed areas, as a perimeter protection around a soil stockpile, as a sediment barrier in low flow drainage swales or around drainage outlets and catch basins.
- Full contact with the ground is critical to prevent short circuiting under the tube - the ground surface should be smooth and level. In wooded areas, protruding roots and debris may need to be removed. In grassed areas, the grass needs to be either mowed or compressed down.
- Staking may be necessary on steep slopes.
- Upon final stabilization, the tube can be cut open and the material spread out onto the ground. The mesh material should be removed.

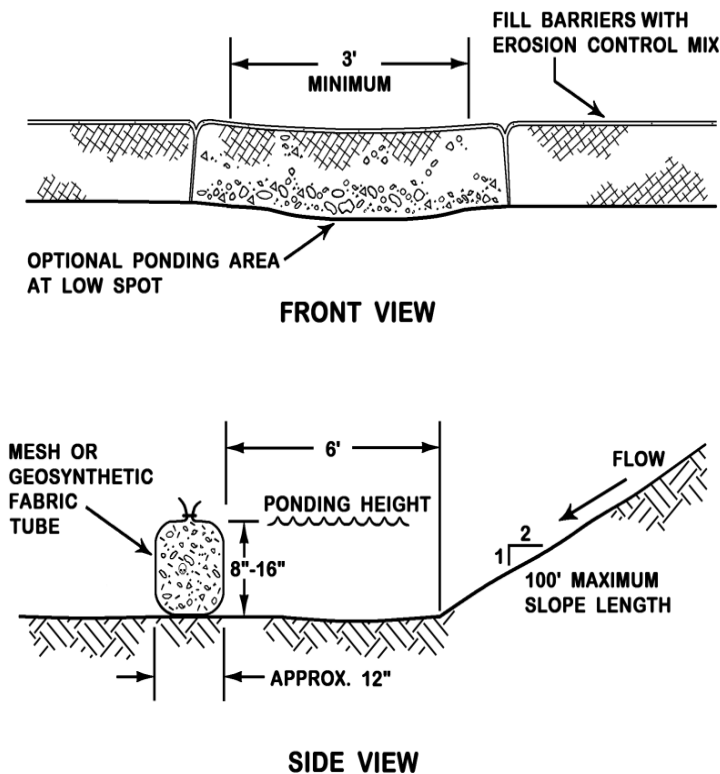

Continuous contained berms may be placed by hand, machinery or the sock may be filled on-site by a pneumatic blower.

4. STONE CHECK DAMS

Stone check dams are constructed across a swale or drainage ditch to reduce the flow velocity and erosive forces and to promote the deposit of sediments. Stone check dams are most important in channels with a slope greater than 6%. They are not effective for silts and clays. Other proprietary products are available and should be used and installed per the manufacturer's guidelines.

IMPORTANT NOTE

- Check dams are intended for the settlement of sediments and flow velocity reduction. A ditch lining that is adapted to the slope will be necessary for erosion control (i.e. one row of erosion control blanket at a minimum).

ENGINEERING DESIGN

- The **spacing** between dams should be based on the amount and velocity of anticipated flows, soil erodibility and slope of the channel. Each check dam should be spaced such that the toe of the upstream dam is at the same elevation as the top of the downstream dam.

CONSTRUCTION SPECIFICATIONS

- Check dams should be installed before runoff is directed to the swale.
- The area around each check dam should be free of debris.
- A stone check dam should be comprised of well-graded crushed rock with a maximum size of 6 inches and a minimum stone size of 1 inch. Larger stones may be used on steep slopes.
- The maximum height of a stone check dam should be 2 feet with a 6-inch depression at its center for overflow. The edges of the dam should be keyed onto the embankments to prevent side erosion.
- Mechanical placement followed by hand placement will be necessary to achieve a tight mass within the channel and to ensure that the center of the dam is lower than the edges.
- Any erosion downgradient or around the edges of stone check dams should be corrected immediately.
- The check dams may be removed when the swale is stabilized with vegetation (90% coverage).

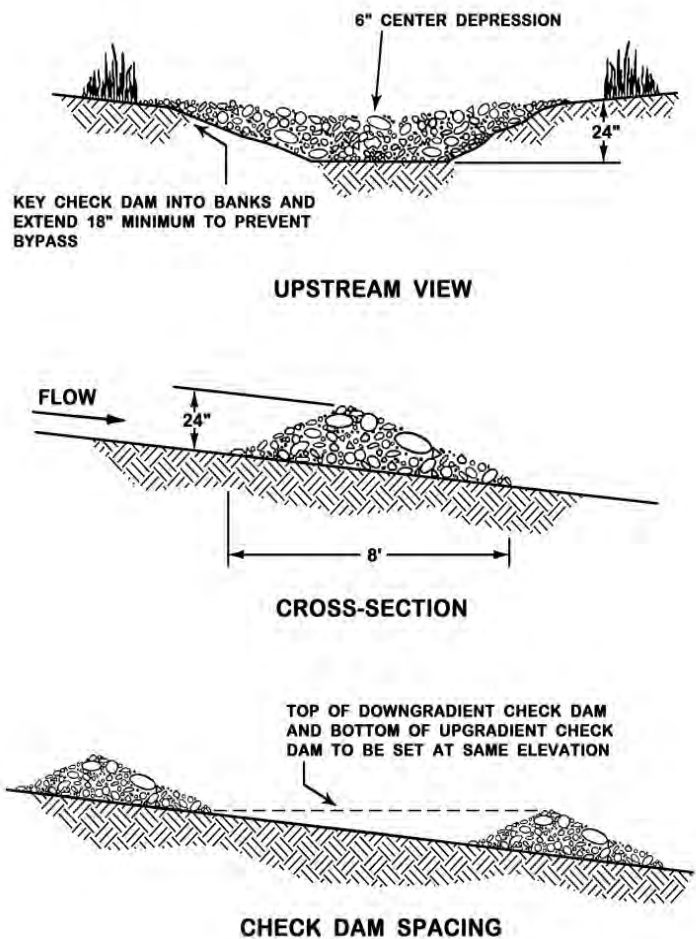

5. STORM DRAIN INLET PROTECTION

An inlet protection (storm drain drop inlet or curb inlet) captures sediment before runoff enters a catch basin. It is not effective for silts and clays. Various types of off-the-shelf devices are acceptable if installed, used, and maintained as specified by the manufacturer.



CATCH BASIN INSERTS or filter sacks made of woven geotextile are reusable. Use should follow the manufacturer's guidelines. They are suspended below the grate and have a built-in overflow for large storm flows. The insert should be removed and the catch basin cleaned at the end of the construction project.

CONCRETE BLOCKS placed on their side around the inlet and wrapped in geotextile fabric should be surrounded with crushed stone (1-2 inch diameter and clean).



SAND-FILLED BAGS butted together around the perimeter of a storm drain may be used if the bags are staggered to make a stable barrier. The berm should have a minimum height of 12 inches.

SILT FENCE WITH GRAVEL may be placed around the perimeter of a catch basin and surrounded with gravel.

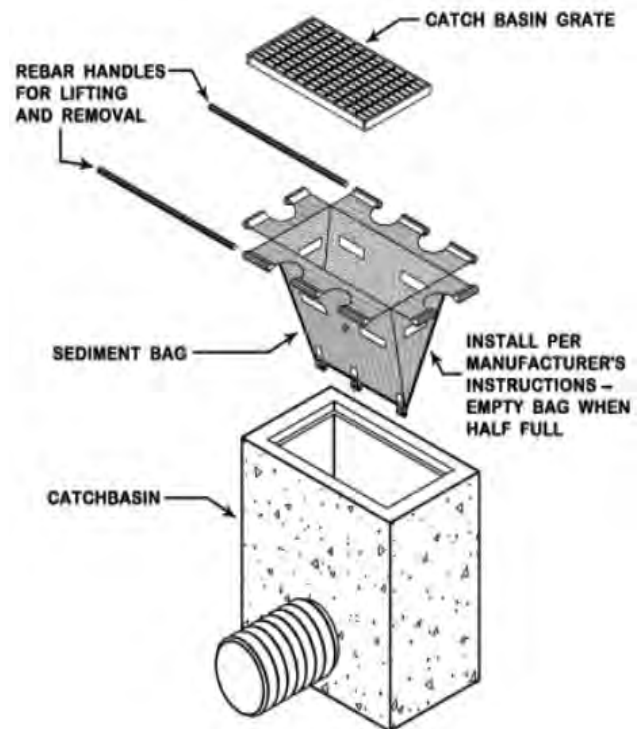
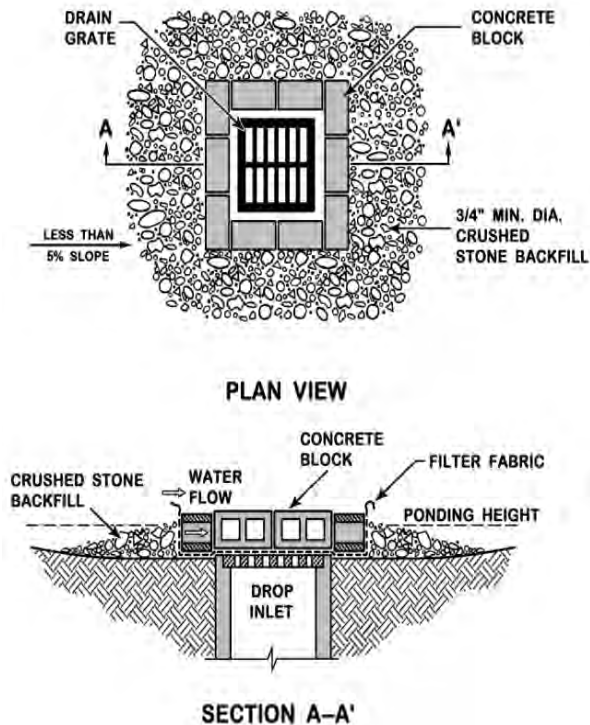

6. HAY BALES

Hay (or straw) bales should only be used as a sediment barrier for a small disturbance with a limited watershed. Their use may also be a simple and effective emergency measure for controlling unexpected sedimentation.

CONSTRUCTION SPECIFICATIONS

- Hay bales should be installed so that the bindings are oriented parallel to the ground to delay their deterioration (hay bales will not last through a construction season and will need to be replaced).
- The barrier should be entrenched a minimum depth of 4 inches. The gaps between bales should be chinked (filled by wedging) with hay to prevent the flow of water between the bales. For small areas or near a protected resource, trenching may not be necessary.
- At least two stakes per bale should be driven into the ground for anchoring. The first stake is driven toward the previous bale to force them together.
- After the bales are staked and chinked, the excavated soil should be backfilled and packed against the barrier to the ground level on the downhill side and 4 inches up the uphill side.



Bales should be limited to small sites or short slopes. But, in an emergency, a row of hay bales may provide an immediate but temporary line of defense.

C. SEDIMENT CONTAINMENT

A temporary sediment trap or basin intercepts and pools runoff for settlement; but it should be installed prior to any site disturbance and should always discharge to an area that is stable. As a general rule, sands and gravels settle rapidly, silt requires 24 hours or more; and clays may never settle.

COMPANION BMPS: Construction Dewatering, Sediment Barrier, Road Ditch Turnouts and Level Spreaders

IMPORTANT NOTE

The containment area should not be removed before the area is fully stabilized. Regularly check for leakage, short-circuiting and overtopping. Inspect the receiving area for soil erosion or sedimentation. Diversion ditches may be necessary to direct runoff to the basin.



Remove sediments when accumulation reaches the mid-point depth of the trap.



An emergency spillway is necessary unless a piped outlet can pass all peak flows without overtopping the embankment.

1. SEDIMENT TRAPS

A sediment trap can be above ground with a perimeter berm, within a natural depression, or in an excavated depression. The drainage area to a trap should be small, and the discharge should be directed to a stable, moderately flat (<5%) area within at least 25 feet of healthy vegetation. Sediment traps are not designed to work within a drainage way with high flow volumes or velocities.



ABOVE GROUND SEDIMENT TRAPS may be an enclosed perimeter of hay bales or concrete barriers lined with non-woven geotextile, or a silt-fence enclosure buttressed by sandbags. The area should be cleared of woody vegetation that may damage the fabric and cause leakage.



NATURAL DEPRESSIONS or excavated basins may be adapted to detain runoff. A low point in a natural depression could be blocked off by a temporary embankment (berm or sand bags) to increase its capacity. The embankment should be high enough to detain the expected volume of water, wide enough to resist collapse; and be appropriately stabilized.

ENGINEERING DESIGN

- A partial **embankment** and overflow structure within a swale can effectively detain water to promote settlement. The embankment should be at least 12 inches above the crest of the outlet and be fully stabilized with either riprap or mulch.
- The **capacity of a sediment trap** should be equal to the stormwater volume to be detained; plus the volume of sediment expected to be trapped.
- An embankment trap with an **earthen spillway** should have a small drainage area relative to the ponding area (no more than 24:1 ratio).

2. SEDIMENT BASINS

If designed accordingly, a permanent stormwater basin may be used as a sediment detention impoundment during construction.



Construct and stabilize a sediment containment structure before disturbing the site and stabilize before a rainfall event.



Stabilization should occur within 7 calendar days with riprap, erosion control mix or an anchored erosion control blanket. Runoff should be directed around the construction area if possible until the basin is stabilized.

ENGINEERING DESIGN for Sediment Basins

- Additional information may be found from the **USDA Natural Resource Conservation Service** design manual for water and sediment control basins.
- The pond's **length to width ratio** should be maximized to promote settlement (2:1 or more). Baffles may be installed in basins to settle sediment.
- A **sediment basin** should be more than 100 feet away from a natural resource and should not discharge directly to a stream (potential impact from elevated water temperatures).
- The **capacity of a sediment basin** should equal to the stormwater volume to be detained plus the volume of sediment expected to be trapped.
- A **permanent stormwater basin** may be used as a sediment basin if the outlet (spillway or pipe) has the capacity for a 10-year 24-hour storm event and the basin is stabilized. Restoring the basin's capacity and stability may be necessary before it is transitioned to a stormwater management structure.
- **Test pits** may be necessary to determine the native soil for excavation depth, embankment foundation and groundwater depth. Suitable excavated materials may be used as permanent fill; but stockpiles should be located away from the excavation or a protected natural resource.

ENGINEERING DESIGN for Embankments

- A **cutoff core** of impervious material should be provided upstream of the dam centerline and the length of the embankment, and should be keyed into undisturbed soils for seepage control. The width of the core should allow for equipment operation, backfilling, and compaction and should be clear of stumps, roots, stones, gravel or sand. All different materials (backfill, core or drain) should be placed together to prevent unequal loading.
- The **foundation area** should be compacted and scarified to tightly bond with the fill material. Fill material should be placed in 6-8 inches layers for compaction. Compaction should meet 95% of maximum dry density by Standard Proctor.
- **Moisture content** of the fill should be adequate for proper compaction and the fill should be free of sod, roots, frozen soil and stones larger than 6 inches. If fill sectioning is required, the bonding edges should be no steeper than 30% and scarified.
- The **texture and gradation** of the fill should be comparable to the native material to prevent permeable lenses or pockets. The more impervious material should be placed at the core or upstream of the embankment.
- Areas adjacent to **structures or pipe conduits** should be compacted by hand tamping or manually-directed power tampers (plate vibrators) to a density equivalent to the fill.
- The **combined side slopes** of a basin should be no less than 5:1, and no embankment should be steeper than 2:1 unless riprapped (an excavated pond may have a 1:1 interior riprapped slope). Steeper slopes may be designed, but these should be approved by a geotechnical engineer.
- To minimize spillway obstruction from ice, debris or embankment settlement, the top of the dam should be 2 feet or more above the **crest of the emergency spillway** or 12 inches above maximum ponding elevation with the emergency spillway flowing at full capacity. Some settlement should be planned for when establishing the height of a dam.
- The top width of the berm should allow access for maintenance vehicles without putting the embankment at risk of failure. The minimum **top width of an embankment** is as follow

EMBANKMENT HEIGHT	<6'	6' – 10'	10'-15'	>15'
TOP WIDTH	4' (or temporary sediment basins)	6'	8'	10'

CONSTRUCTION SPECIFICATIONS for Embankments

- The embankment foundation area should be cleared of stumps, roots, brush, boulders, etc. to provide good contact.
- The native soil should be scarified and have sufficient moisture for the first layer of fill.
- An overflow outlet or spillway should be constructed within the embankment, and be protected with geotextile fabric and riprap. The center of the spillway should be at least 6 inches lower than its outer edges. A rock outlet may be necessary for velocity dissipation.
- Basins should have a minimum depth of 2 feet, with embankments that are stabilized (erosion control mix, riprap or sand bags).
- The fill material should be free of roots, frozen soil and stones. Fill should be placed in 6-inch lifts before compaction for a good bond between layers. Lenses, pockets, or uncompacted layers are not acceptable. If materials of varying texture should be used, the more impervious material should be placed in the center or upstream of the embankment.
- The moisture content of the fill material should be adequate for compaction.
- The top of the embankment should be at least 18-inches above the crest of the riser.
- Fill adjacent to structures, pipe conduits, and anti-seep collars should be compacted to 95% Standard Proctor density. Fill adjacent to poured in-place concrete structures should not be compacted until the concrete has gained the strength to support the load.

ENGINEERING DESIGN for Emergency Spillways

- An **emergency spillway** must be provided unless the principal spillway is designed to discharge all design flows without overtopping the embankment (an emergency spillway is unnecessary for a 24-inch discharge pipe or larger if not constrained by upstream orifices or control structures).
- The **discharge flow from the primary outlet** may be included in sizing an emergency spillway.
- The **flow velocity** from the spillway should be controlled to prevent downstream channelization. Emergency spillways should be located in an undisturbed area or over compacted soils.
- The **upgradient channel** to the spillway should be trapezoidal and level; and the grade of the exit channel should not exceed permissible velocities for the soil type.
- **Chutes or drops** should be designed according to the USDA principles for detention ponds.

CONSTRUCTION SPECIFICATIONS for Emergency Spillways

- The construction of the spillway should occur simultaneously with the construction of the embankment and should be stabilized immediately as it will be discharging water with the next rain event.
- Equally, the receiving area of the discharge must be stable with the flow distributed through a plunge pool and level spreader to prevent channelization.
- Riprap sizing should be based on anticipated discharge flows, and the rocks must be angular and hard.

ENGINEERING DESIGN for Piped Outlets

- All **piped outlets** should be sized for design flows and maximum hydraulic head without activating the emergency spillway. Under flooding condition, the emergency spillway should activate before full flow is reached out of the primary outlet. If the diameter of a piped outlet is 10 inches or greater, it can be included with the flow from the emergency spillway in calculating the peak outflow for high storm events. The diameter of a piped outlet should be greater than 4 inches.
- A temporary **perforated outlet riser** should have its top 2/3 perforated with 1-inch holes or slits, and be wrapped with a geotextile fabric that is secured (strapping or connecting bands). Anchoring weight (concrete base or steel plate) and a 3-4 foot wide cone of clean gravel will prevent flotation of the riser and provide filtration of the outflow.
- The outlet pipe material should support the design load with a **5% maximum deflection**; and all joints should remain watertight (with couplings, gaskets, caulking, or by welding) while allowing joint elongation from soil compaction. Any closed conduit designed for pressure flow should have an anti-vortex device.
- **Seepage control** with an anti-seep collar should be provided for basins deeper than 15 feet, or for smooth pipes larger than 8 inches in diameter (12 inches if corrugated). Collar material must be compatible to the pipe and have a watertight connection. The spacing between anti-seep collars should be approximately 14 times the projection of the collar measured perpendicular to the pipe (or one foot projection every 14 feet) for the seepage path to be increased by 15%.
- A **filter and drainage diaphragm** should be provided for seepage along the outlet pipe if anti-seep collars are inadequate. The drain should consist of fine concrete aggregate (15% or more passing the No. 40 sieve and less than 10% passing the No. 100 sieve). The drain should begin 18 inches below the conduit invert and extend on top at least three times the pipe diameter (for a drainage structure that is approximately 5-6 times the diameter of the pipe). The drain diaphragm should be parallel to the centerline of the dam and should start immediately downstream of the core. The drain should outlet away from the embankment toe and be protected from surface erosion.
- If possible, the **elevation of the primary outlet** should be more than 6 inches below the crest of the emergency spillway.
- A **trash guard** at the conduit inlet should prevent clogging.
- A **valve on the outlet** can be provided to drain the pool area for maintenance.

CONSTRUCTION SPECIFICATIONS for Piped Outlets

- A piped outlet can be fitted to a basin instead of an overflow spillway. The capacity of the outlet should be adequate to discharge anticipated flows.
- The perforated riser pipe should have its top 2/3 perforated or slotted up to the top six (6) inches of the barrel. The outlet should be surrounded with geotextile and a cone of gravel to filter the fine sediment particles.
- The riser should be weighted by a base (i.e. 12- inch thick concrete block or ¼-inch thick steel plate) and gravel to prevent flotation.
- All pipe joints should be watertight using couplings, gaskets, caulking, or welding.

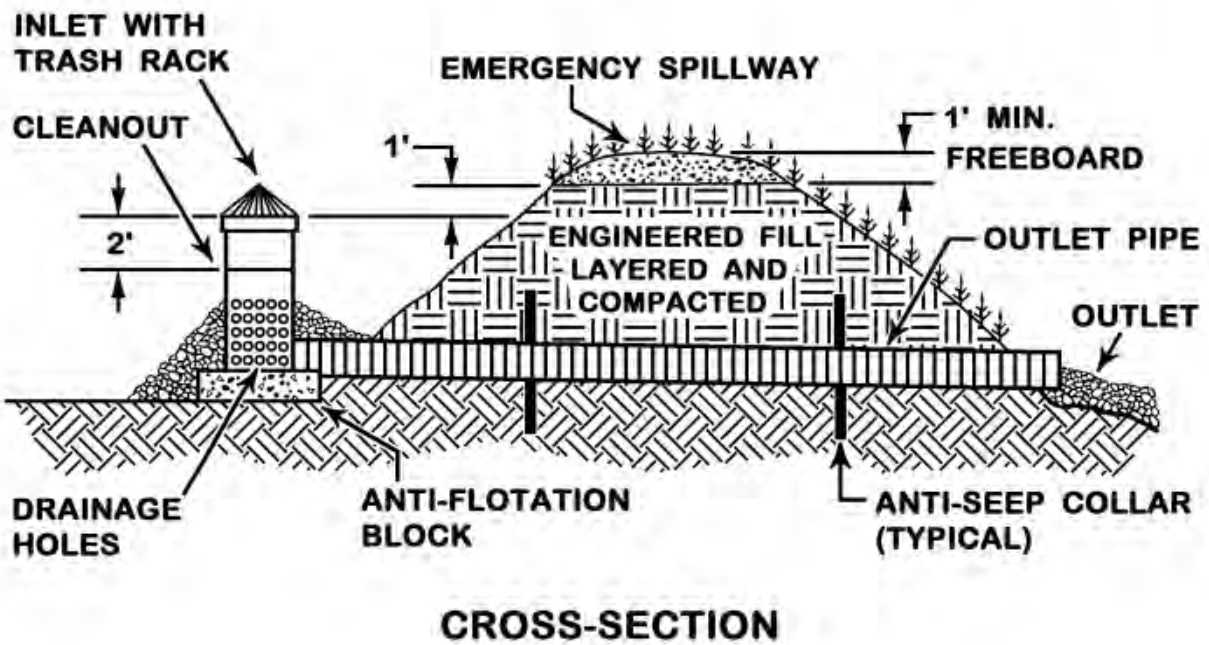
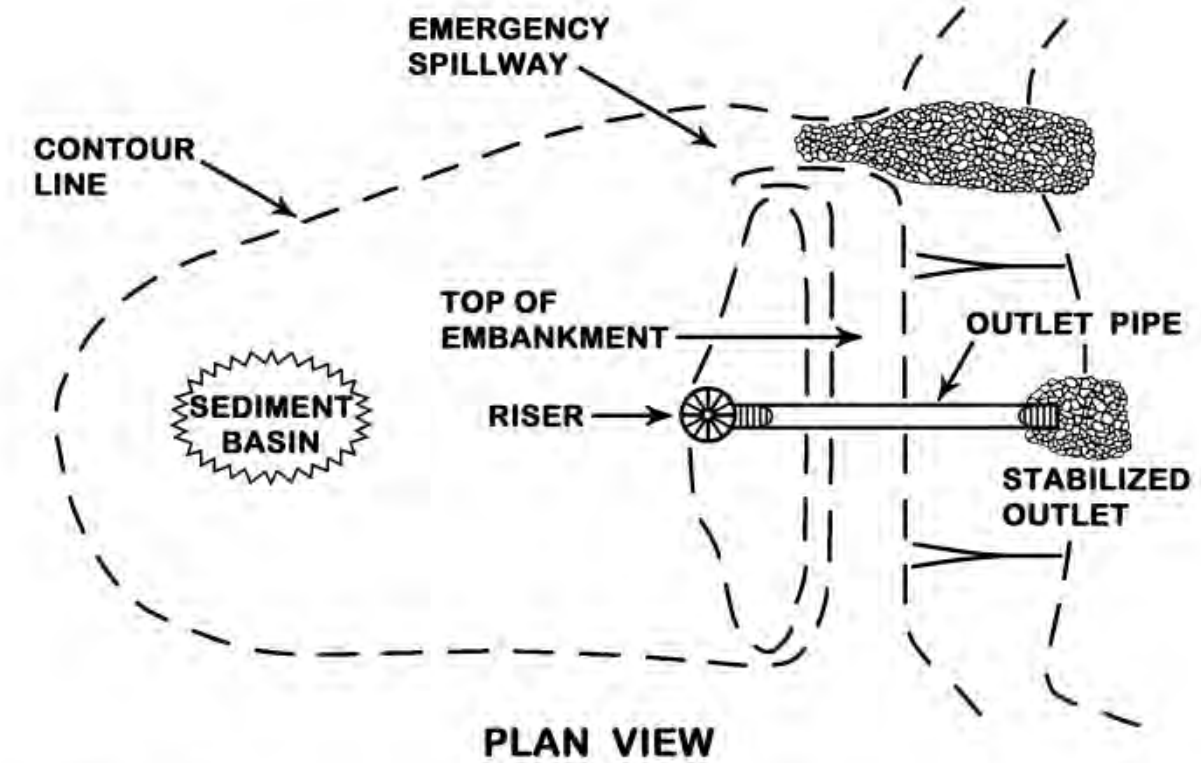

SIZING OF A DETENTION POND

This example is presented as a guideline and is recommended for those familiar with the Rational Method or TR55. More information may be obtained from the USDA-NRCS design guidance for water and sediment basins.

DETERMINE:

Maximum required principal spillway discharge: $Q_{outflow} = Q_{outflow}/Q_{inflow} \times Q_{inflow}$

Minimum required detention storage volume: $V_{storage} = V_{storage}/V_{runoff} \times V_{runoff}$

GIVEN:

Drainage Area, DA	100 acres
Curve Number, RCN	75
Storm Event	10-year/24-hour/Type II
Precipitation, P	5.4 inches
Soil Type	Exposed Clay/Silt
Detention Time	24 hours
Time of Concentration, T _c	0.45 hour

PROCEDURE:

- Find the volume of runoff V_{runoff} in inches (TR-55 or other acceptable method): $V_{runoff} = 2.8$ (sometimes referred to as Q)
- Determine the peak runoff rate in cfs by using TR-55: $Q_{inflow} = DA \times V_{runoff}$
 DA (in sq miles) = 100 acres/640 acres/sq miles
 $V_{runoff} = 2.8$ inches
 $Q_{inflow} = 572 \text{ csm/in} \times 100/640 \text{ sq. miles} \times 2.8 \text{ inch} = 250 \text{ cfs}$
- $Q_{inflow} / DA = 250/100 = 2.5 \text{ cfs/acre}$
- Use **Graph C.1** with $V_{runoff} = 2.8$ in, $Q_{inflow}/DA = 2.5 \text{ cfs/acre}$ to obtain $Q_{outflow}/Q_{inflow} = 0.031$
- Find maximum required principal spillway discharge:
 $Q_{outflow} = Q_{outflow}/Q_{inflow} \times Q_{inflow} = 0.031 \times 250 = 7.8 \text{ cfs}$
- With $Q/Q_{inflow} = 0.0312$ find $V_{storage}/V_{runoff}$ by appropriate method
 Equation for $V_{storage}/V_{runoff}$ per TR-55 ($V_{storage}/V_{runoff} = 0.638$)
- Volume of runoff (acre-feet) = V_{runoff} (inch) x A (sq miles) x 53.33
 $= 2.8 \times 0.156 \times 53.33$
 $= 28.38 \text{ acre-feet}$
- Find volume of storage where: $V_{storage} = V_{runoff} (V_{storage}/V_{runoff})$
 $= 23.38 \times (0.638)$
 $= 14.88 \text{ acre-feet}$

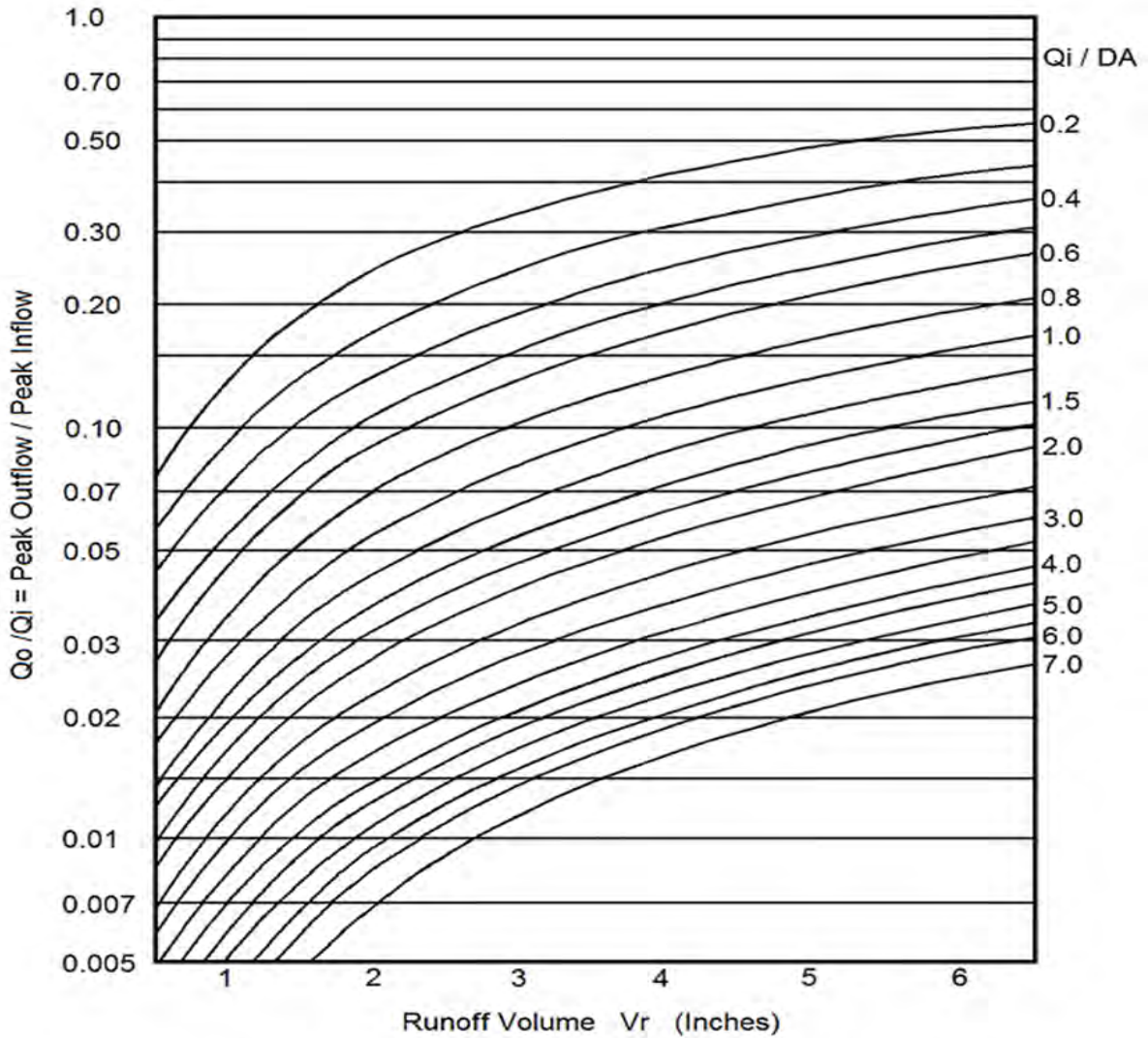

Maximum Peak Outflow for Detention Time, T = 24 Hours

Graph C.1. "Peak outflow/peak inflow" as a function of "runoff volume" and "peak inflow/drainage area".

3. GEOTEXTILE FILTER BAG

A geotextile filter bag is a prefabricated sack that is used to filter sediments from dewatering activities. A filter bag should be used in accordance with the manufacturer's recommended guidelines. Consult the DEP if the structure will be within 75 feet of a protected natural resource or if secondary containment is required.

CONSTRUCTION SPECIFICATIONS

- Install the filter bag prior to initiating any activities which will require dewatering.
- The type of fabric should be based on the size of soil particles to be trapped (i.e. a woven material for coarse particles and a nonwoven material for finer particles).
- A filter bag should be located in an area mostly level (with less than 5% slope). A pad of crushed gravel may be provided.
- Avoid discharging to an area that is bare of vegetation or newly vegetated. Any sign of erosion or channelization from the discharged water requires immediately correction.
- Filter bags have a finite capacity for sediment collection and may be prone to plugging. Avoid over-pressurizing the bag or it may burst.
- If a sediment discharge is observed, inspect the filter bag for tears or other malfunctions.

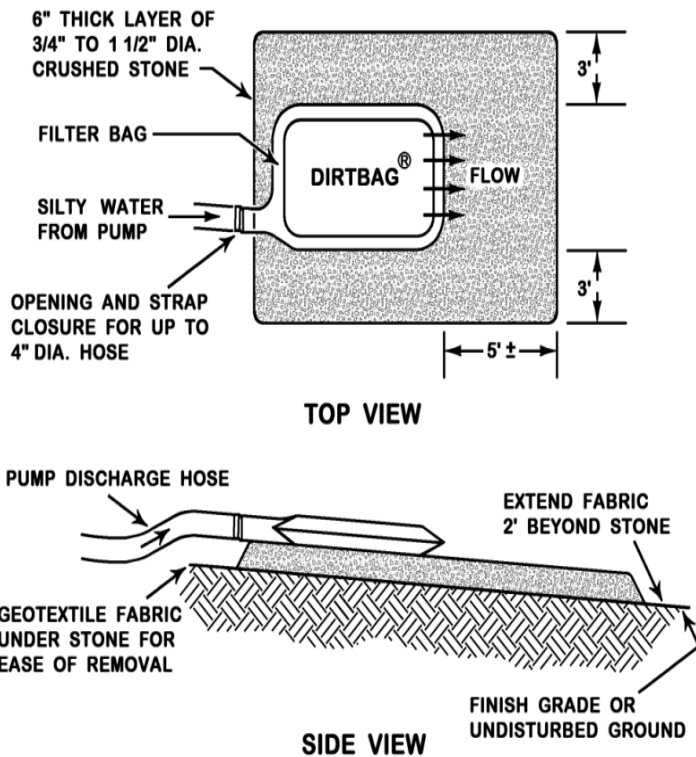

4. FLOCCULANTS (POLYMERS)

Flocculants, which are generally polymers (e.g. polyacrylamides), bind soil particles to each other and facilitate their settling. They can be neutral, positively (cationic) or negatively (anionic) charged. Flocculants can be applied directly to stormwater for turbidity removal or topsoil for erosion control. They decrease the settling time of suspensions and increase pore volume, permeability, and infiltration of the soil. Flocculants are particularly effective on silt and clays.

Flocculants are available in four types of media (powder, liquid, emulsion or gel block). The powder, liquid, and emulsion media can be applied directly for immediate stabilization. Gel blocks are used for the settlement of suspended soil particles in flowing water.

The use of cationic flocculants is not recommended in the state of Maine.

The supplier's recommendations are important to follow, and soil and water testing is critical to select the correct flocculants, additives, dosing rate, and dosing method. Be aware that there are many available flocculants that may not have third-party approval for toxicity to aquatic life.

CONSTRUCTION SPECIFICATIONS

- Flocculants should be applied above a sediment trap or basin. Any remaining particulates in a treated discharge require immediate correction.
- Consult with the DEP if the treated runoff is to enter directly into a protected natural resource.
- As a liquid or in a powder, flocculants can be used for dust control or for stabilization before vegetation can establish. Reapplication will not be necessary if the site is seeded and mulched as the polymers will reduce the loss of seeds and fertilizer.
- Pools and riffles within a drainage channel will ensure mixing and contact time with a gel block to promote the settlement of soil particulates.

D. MULCHING

Mulching is the application of an organic cover over exposed soil to protect its structure from the impact of raindrops, to reduce the potential for erosion, and to maintain soil permeability and moisture for vegetation uptake. Erosion will occur where the soil does not have firm and continuous contact with an erosion control cover. Mulch must remain until the site is permanently stabilized or revegetated.

COMPANIONS: *Vegetation, Swales and Ditches, Cross Culverts, and Slopes*

ENGINEERING DESIGN

- Require **mulching** per weather prediction, soil erodibility, season, extent of disturbance, etc. within 7 days in sensitive areas (within 100 feet of a natural resource) or within 14 to 30 days in other areas.
- Mulch should be used with trees, shrubs, vines and for all ground cover plantings.
- Anchor **hay mulch** with stapled mesh netting or by stretching twine in a crisscross pattern between pegs (4-6 pegs per square yard, 2-3 inch deep). Drive the pegs flush with soil where mowing is planned.
- The recommended thickness for erosion control mix is 4 inch plus an additional 1/2 inch per 20 feet of slope up to 100 feet if the slope is steeper than 3:1.
- A **temporary road or an unfinished road** (without its final driving surface of gravel) may require mulching prior to a rain event.
- **Erosion control mix** should contain a well-graded mixture of particle sizes and may contain rocks less than 4" in diameter. Erosion control mix should be free of refuse, physical contaminants, and material toxic to plant growth such as fly ash or yard scraping. Large portions of silts, clays or fine sands are not acceptable in the mix. The mix composition should meet the following standards:
 - The organic matter content should be between 80% and 100%, dry weight basis.
 - Particle size by weight should be 100% passing a 6" screen and 70% to 85% passing a 0.75" screen.
 - The organic portion needs to be fibrous and elongated.
 - Soluble salts content shall be < 4.0 mmhos/cm.
 - The pH should be between 5.0 and 8.0.

CONSTRUCTION SPECIFICATIONS

- Hay, hydraulic mulch or erosion control blankets should be installed immediately over a new seeded bed, or if near a protected natural resource. Mulching is also recommended before any expected rain, and in the winter.
- A site will be considered permanently stabilized when supporting a ground cover of 90% vegetation. If the mulch needs to be removed for better vegetation growth (as in the spring time), it can be spread out.



Areas which cannot be revegetated before winter must be mulched at the winter rate with double the mulch and with dormant seeding for spring growth if the site is ready to be permanently stabilized.

Inspect the mulch cover weekly and prior to, during and after any storm event until full vegetation uptake. New mulch should be applied if the soil becomes exposed and before washouts occur.

MULCH	APPLICATION RATE	BENEFITS	LIMITATIONS
Straw or Hay	2 bales (70-90 lbs)/1000 sq.ft for over 75% coverage Twice that rate for overwinter stabilization	Available and inexpensive It can be applied via blower on larger sites	Anchoring or tackifier is needed on steep slopes or in windy areas, or must be crimped Hay imports weed seeds
Erosion Control Mix	2 inches for slopes flatter than 3:1 or 4 inches for slopes greater than 3:1 The mix must contain some soil	Low cost if available Effective on up to 45% slopes	Will not revegetate very quickly. Elongated and fibrous woody parts
Hydraulic mulches and soil binders	Can include seeds, fertilizer or soil binders Paper mulch: 5 lbs/1000 sq. ft Cellulose fiber: 40 lbs/1000 sq. ft	Easily and rapidly applied with sprayer equipment.	May be too expensive for a small or remote site and more protection needed on steep slopes Should dry at least 24 hours before rainfall
Erosion Control Blankets	Staple per manufacturer's specifications	Effective for grassed ditches or steep slopes. Great for overwinter stabilization	May be expensive for large sites Needs good soil contact
Wood Chips and Bark Mulch	3 inches or more for flat areas or on short 4:1 slopes	Available from construction site Low cost	Will wash away Will revegetate very slowly

1. HAY/STRAW MULCH

Hay (straw will not import weeds) mulch prevents rain drop erosion, protects new seeding from sun exposure, and maintains moisture during germination. Loose mulch is not effective in windy areas, in areas of groundwater seepage or in channels with concentrated flows.

CONSTRUCTION SPECIFICATIONS

- Temporary mulch should be applied to areas that will not be actively worked for more than 14 days (7 days in sensitive areas).
- Application rate should be 2 bales (70-90 pounds) per 1000 square feet or 1.5 to 2 tons (90-100 bales) per acre and must be evenly distributed.
- Provide a mulch cover to soil stockpiles.
- Anchoring should be provided in areas with strong wind or on slopes greater than 5%.
- Hay mulch should be limited to slopes flatter than 2:1 unless short (less than 10 feet), and in non-seepage areas. Another measure should be used on steeper slopes with a high runoff potential.
- Anchoring can be accomplished by punching, crimping the mulch into the soil or tracking with a punch-roller or a knife blade roller. Walking and punching with a spade or shovel may be practicable on very small sites.
- Peg and twine or netting should be installed per the manufacturer's recommendations. Non-biodegradable plastic netting should be removed after the site is revegetated.
- Apply additional mulch if not revegetated with 90% grass uptake.



A mulch cover should be heavy enough to resist disturbance or should be anchored. It will last only 2-3 months and may need to be reapplied if grass growth is inadequate.



Loose hay mulch is not recommended in areas of seepage or concentrated flows.

2. EROSION CONTROL BLANKETS

An erosion control blanket (or mat) is a machine-produced blanket of organic fiber, sewn into a biodegradable mesh (or geo-web cellular structure for more reinforcement). Organic mats are available as jute, excelsior wood fiber, coconut fiber, straw, and others.

Blankets are designed to retain the soil moisture and maintain a constant temperature for seed germination; and they are most useful where hay cannot sustain wind or water disturbance or when the site is to overwinter. An erosion control blanket could be used in the following conditions:

- Vegetated waterways and ditches; but not in areas of groundwater seepage
- Steep slopes (15% or greater and up to 2:1)
- In protected natural resource areas
- On areas that may be slow to revegetate
- For overwinter stabilization (November 1st - April 15th)

CONSTRUCTION SPECIFICATIONS

- The soil surface should be finely graded and smooth for the blanket to have direct contact with the soil and to prevent undermining. Erosion control blankets perform best on loamy soils and should not be used on rocky sites or shallow soils.
- Seed should be sown before installing the erosion control blanket.
- Always unroll the blanket downhill without stretching and anchor the upslope edge in a 12 inch deep trench that is backfilled and tamped.
- Overlap shingle style a minimum of 12 inches at the top of each row and 4 inches at the edges of parallel rows. Anchor along the overlap with a maximum spacing of 3 feet or as required by the manufacturer.



A continuous contact between the mat and the soil is critical, otherwise the mat may fail.



The matting should be anchored and stapled per the manufacturer's recommendations.

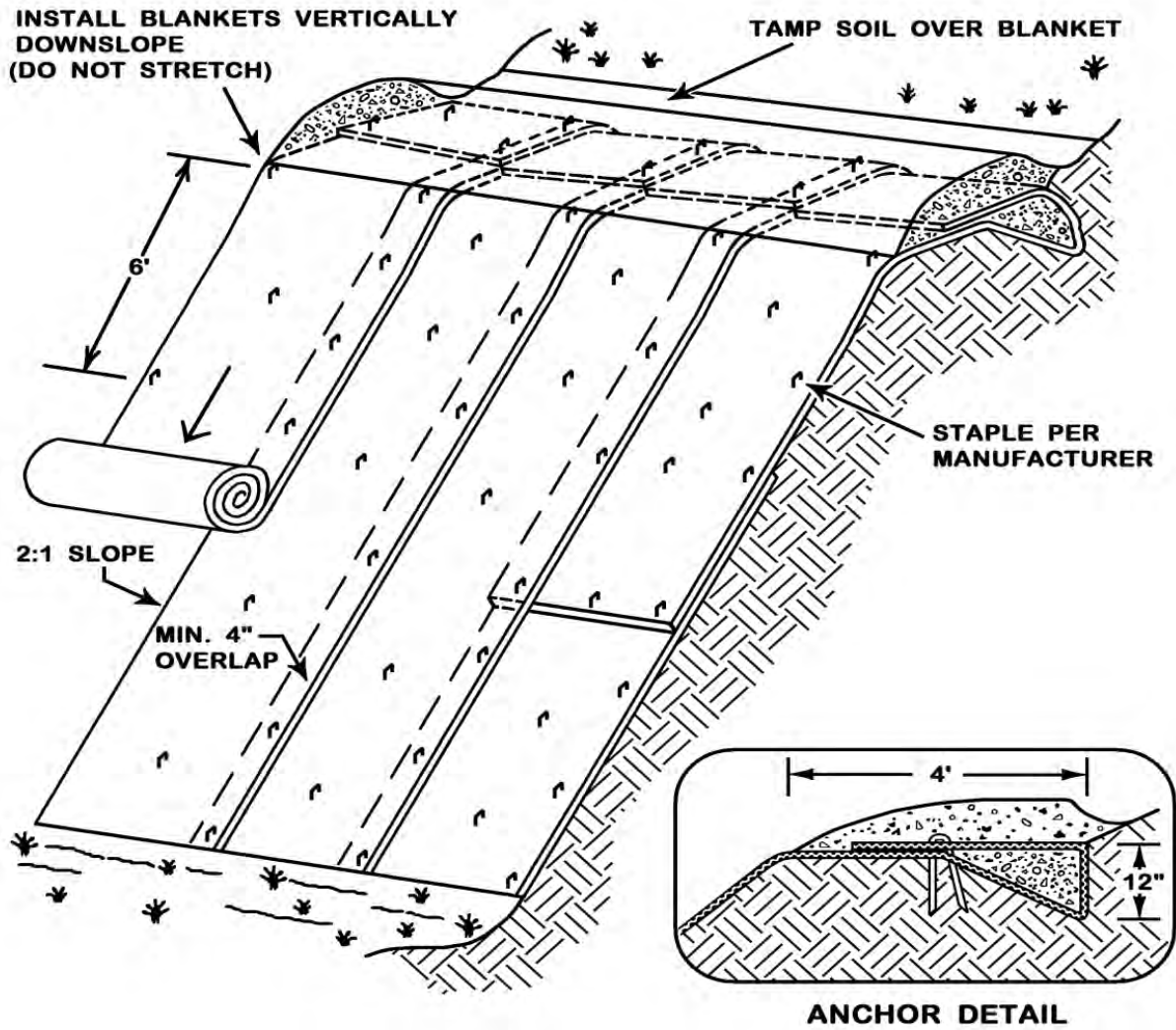

3. EROSION CONTROL MIX

Erosion control mix is a dense, processed mixture of intertwining shredded wood fragments and grit that will stabilize a site immediately without vegetation. Erosion control mix will prevent erosion on a slope up to 1:1. Erosion control mix consists primarily of organic material manufactured on or off the project site and may include: shredded bark, stump grindings, or partially composted wood products.

IMPORTANT NOTE:

The mix must be well-graded with an organic component that is between 50 and 100% of dry weight, and that is composed of fibrous and elongated fragments. The mineral portion of the mix should be naturally included in the product with no larger rocks (>4") or large amounts of fines (silts and clays). In stump grinding, the mineral soil originates from the root ball and should not be removed before grinding. The mix should be free of refuse, material toxic to plant growth or unsuitable material (bark chips, ground construction debris or reprocessed wood products).

DESIGN SPECIFICATIONS

- Erosion control mix can be used on frozen ground, forested areas, on cut and fill slopes, and on roadside embankments.
- Apply a thickness of 2 inches on 3:1 slopes or less and add an additional 1/2 inch per 20 feet of slope or up to 4 inches for a 100 foot slope.
- On slopes greater than 3:1, 4 inches or more of material is recommended; and if slopes are greater than 60 feet long, 5 inches are needed.
- Erosion control mix is not recommended for slopes steeper than 1:1.
- The mix must be distributed evenly with a hydraulic bucket, pneumatic blower, or by hand.
- Other reinforcement BMPs (i.e. riprap) should be used on slopes with groundwater seepage, within drainage channels and their outlets, or in gullies.



While it decomposes, erosion control mix will deprive the soil of nitrogen necessary for plant growth unless legumes, such as clover or crown vetch, are used.

4. HYDRAULIC MULCH

Hydraulic mulch is a mixture of mulch (paper, cellulose and wood fiber), binder, and water that is sprayed with or without seeds and fertilizer to stabilize a soil surface. It may be used as a 'tackifier' to secure hay mulch in windy areas. Consult the manufacturer or applicator for more information on the use and application of each specific product.

CONSTRUCTION SPECIFICATIONS

- Hydraulic mulch should be applied within one week of final grading. Avoid applying on windy days. Higher rates of mulching should be used on areas subject to wind.
- Apply when no rain is predicted for a few days as the mulch binder has a curing time of about 24 hours. Low temperatures will also slow down the curing time.
- Apply a paper hydraulic mulch at a rate of 5 lbs./1000 square feet or as directed by the manufacturer.
- Apply a cellulose fiber mulch mixture at a rate of no less than 40 lbs./1000 square feet or as directed by the manufacturer.



An appropriate mulch mixture should be based on weather and site (soil type, slope, exposure to wind) conditions.

E. VEGETATION

The most permanent, simple and inexpensive stabilization measure is by revegetating a disturbed area. Vegetation is natural, regenerating, protects the soil surface, promotes infiltration, and reduces flow velocity. Seeding and mulching should be applied as soon as possible upon final grading or as a temporary cover if final grading will not occur before 14 days. The vegetation's effectiveness will vary with the underlying soils, slope, and runoff volume and velocity.

IMPORTANT NOTES:

- Long slopes steeper than 2:1 cannot support vegetation unless the soil has good structure and no upgradient watershed.
- All newly seeded areas should be mulched and anchored.
- Deeply rooted plants will be more effective at stabilizing slopes. Incorporate a variety of plants, shrubs, or trees that are native to Maine and require little maintenance.
- Apply limestone and fertilizer only if necessary to prevent impact to surface water or groundwater.

ENGINEERING DESIGN

- Proper **seedbed preparation** and the use of a quality seed mix are as important as permanent seeding.
- **Spring seeding** gives the best results for all seed mixes or legumes. Permanent seeding should occur 45 days prior to the first killing frost, or as a dormant seeding before snowfall.
- Apply **lime and fertilizer** according to soil test results (University of Maine Soil Testing Laboratory or other). If soil testing is not feasible or where timing is critical, fertilizer may be applied at the rate of 800 pounds per acre or 18.4 pounds per 1,000 square feet using 10-20-20 (N-P₂O₅-K₂O) or equivalent. Apply ground limestone (equivalent to 50% calcium plus magnesium oxide) at a rate of 3 tons per acre (138 lb. per 1,000 sq.ft). Work lime and fertilizer into the soil to a depth of 4 inches, and till for a uniform and fine seedbed.
- The seedbed should be firmed with a roller, or light drag except where a cultipacker or hydroseeder was used. The bed will over-compact if the soil contains high amount of clay and silt. Remove all stones 2 inches or larger, debris, roots, concrete, lumps or other unsuitable material.
- **Inoculate all legume seeds** with the correct type and amount of inoculant. Crown vetch is seeded in later summer and 35% of the seed should be hard seed (unscarified).
- **Apply seeds** uniformly by hand, cyclone seeder, drill, cultipacker type seeder or hydroseeder (slurry including seed and fertilizer). Normal seeding depth is from 1/4 to 1/2 inch. Seeding operations should follow the contour.
- Beyond the first killing frost, seeds are likely to germinate, but may not survive the winter.
- **Dormant seeds** may be applied at double the rate; but it should not be used in ditches or near a protected water resource.
- **Temporary grass and legume** can provide a vegetative cover on soils that will not be brought to final grade for an extended period of time. Temporary seeding also preserves the integrity of earthen structures (such as temporary dikes, diversions, and the banks of sediment basins).



Seed and mulch should be applied within 7 days of final grading. If construction extends into the fall and winter months, all erosion control measures should meet winter construction standards.



Divert clean water away from the immediate area and disperse to an undisturbed area to reduce erosion



When hydroseeding, apply the seeds uniformly and per applicator's guidance (10% increase in seeding rate is recommended).



Inspect periodically the revegetated area. To be considered stabilized, 90% of the soil surface should be vegetated or the area may need reseeding and mulching.



For lawns, grass height should be maintained between 2 and 3 inches. No more than 1/3 of the shoot (grass leaf) should be removed by mowing.



A created buffer should also be stabilized with seeding and mulch.

1. TOPSOIL

Topsoil provides a loose medium for root development, and a good quality-topsoil will contain decomposed organic matter which retains nutrients and water for plant growth. The topsoil should be friable, loamy and should be free of debris, trash, stumps, rocks, roots, weeds or any substance that is toxic to plant growth. Properly manufactured topsoil can also be used as a cost effective material.

IMPORTANT NOTE

Laboratory testing for nutrient and content of organic matter is recommended (University of Maine Soil Testing Laboratory or other). Topsoil should have 3-5% of organic matter, no more than 500 ppm soluble salts and a pH range that is between 6.0 and 7.5 (if less than 6.0, lime should be added in accordance with the test results and seed requirements).

ENGINEERING DESIGN

- All **topsoil should be tested** for the following:
 - Organic matter content that is no less than 3% by weight,
 - A pH that is between 6.0 and 7.5 (if pH is less than 6.0, lime should be added in accordance with the soil test results and seeds requirements), and
 - Soluble salts not exceeding 500 ppm.
- Topsoil should be dark from its **organic component** that is indicative of the nutrients needed for the development of root systems. Topsoil is necessary where the subsoil's texture is either too coarse or too fine, pH is low (4 or below), or the nutrient balance cannot be modified. Topsoil is necessary if the subsoil is too shallow for support roots, to supply moisture and nutrients, or the subsoil contains substances toxic to plants.
- **Limed and fertilized subsoils** can provide an adequate medium if moisture is plentiful.
- **Topsoil substitutes** (erosion control mix or soil blends) can be cost-effective and can be tailored to balance or correct the fertility of the existing soil conditions. Contact the generator of the material for information that applies to their material.
- **Soil amendments** such as compost may be an alternative to mining prime farmland soils (which can be high in phosphorus and nitrogen).
- Any subsoil **surface irregularities** should be corrected to prevent depressions or water pockets.

CONSTRUCTION SPECIFICATIONS

- Topsoil should not be placed on frozen, muddy, or an extremely wet subgrade.
- Prior to spreading the topsoil, the subgrade should be loosened or scarified to a depth of at least 2 inches to ensure bonding.
- The topsoil should be 4 inch deep and uniform. Rototilling for a deeper rooting zone on poor subsoils (sloping wet sites or with sand and gravels) is recommended.
- Lightly compact the topsoil to ensure a uniform and firm seedbed (excessive compaction will increase runoff, and prevent seed rooting).

2. SEEDBED PREPARATION

The seed bed should be scarified or roughened after topsoil is added to provide a deeper rooting depth for vegetation, traps moisture for the re-establishment of vegetation, and retains water for infiltration. To prevent compaction, rutting or erosion, the surface should be prepared for topsoil and seeding during a dry period and when the soil is not saturated.

TRACKING by equipment traveling up and down the slope of a seed bed will loosely roughen the area and leave cleat marks parallel to the contours. It is not recommended for soft-wet soils which may overcompact, rut or erode. Tracking may be done over or under a layer of hay mulch.

GROOVING is the process of using agricultural equipment such as a tiller (plow, chisel) or disc harrow across the slope, leaving small ridges. The grooves should be less than 15 inches apart and less than 6 inches deep. Grooving should be limited to slopes flatter than 3:1.

SCARIFICATION is done with a disc chisel, York rake or rototiller. Surface roughening is most appropriate on flat to gentle or short slopes that do not have a shallow groundwater table.



Newly prepared seeded beds should be inspected regularly. Any sign of rill or gully erosion should be repaired as soon as possible.

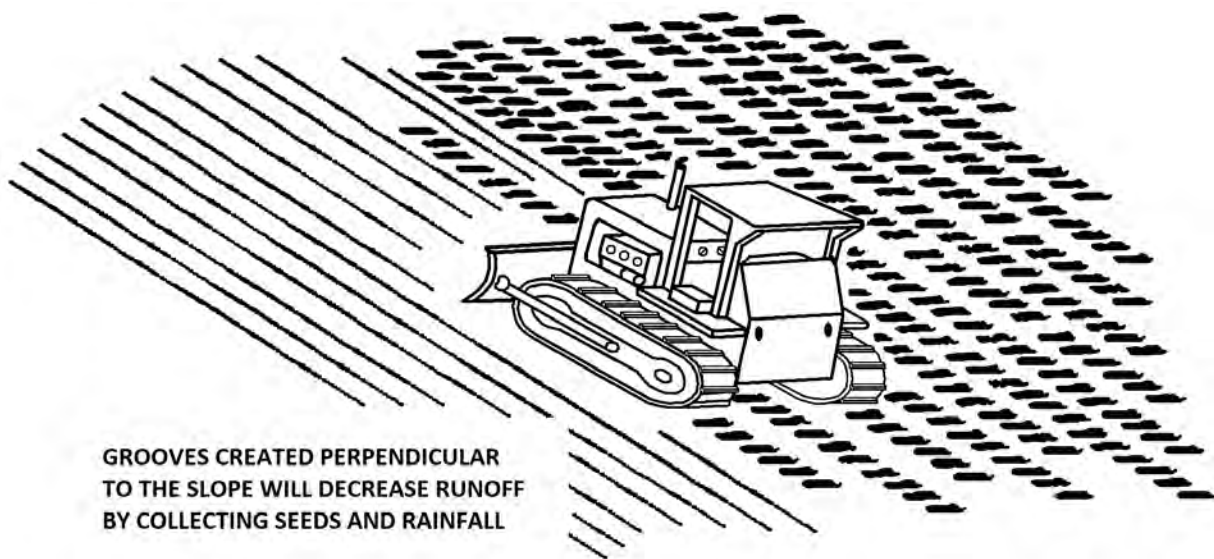

3. VEGETATION APPLICATION

If possible, seeding should occur no later than 45 days before the first killing frost or the seeds are likely to germinate but not survive. Different Maine areas have different frost dates; refer to the following map for the final seeding date of your area.

PERMANENT VEGETATION should be established with a seed mixture that is appropriate for the site’s soil type, moisture content, sun exposure, use (frequency of mowing), etc. The application should follow the supplier’s guidelines for the seed type. Maine DOT or Soil and Water Conservation Districts seed mixtures are recommended.

DORMANT SEEDING should be applied at double the rate of normal seeding between the first killing frost and before snowfall because of their poor survival rate. To improve germination, cover the seedbed with mulch that is well anchored and fully covering the ground surface.

TEMPORARY VEGETATION should be established on an area that will not be worked for 30 days and until it can be permanently stabilized. Annual grasses and legumes are most effective; but they will not reproduce for a second growing season. Inoculate all legume seeds with the correct type and amount of inoculant.

INSPECTION of newly seeded beds should be occur regularly. Any sign of rill or gully erosion should be repaired as soon as possible.

TEMPORARY SEED APPLICATION GUIDELINES				
SEED	Lb / Acre	Lb / 1,000 SF	Seeding Dates	Notes
Winter Rye	112	2.6	8/15 - 10/1	Select hardy species such as Aroostook Rye.
Oats	80	1.8	4/1 - 7/1 8/15 - 9/15	Best for spring seeding. Fall seeding will die over the winter.
Annual Rye Grass	40	0.9	4/1 - 7/1	Grows quickly but is of short duration. With mulch, seeding may be done throughout growing season.
Sudangrass	40	0.9	5/15 – 8/15	Good growth during periods of hot weather.
Perennial Rye Grass	40	0.9	8/15 – 9/15	Good cover, longer lasting than annual rye grass. Mulching will allow seeding throughout growing season.

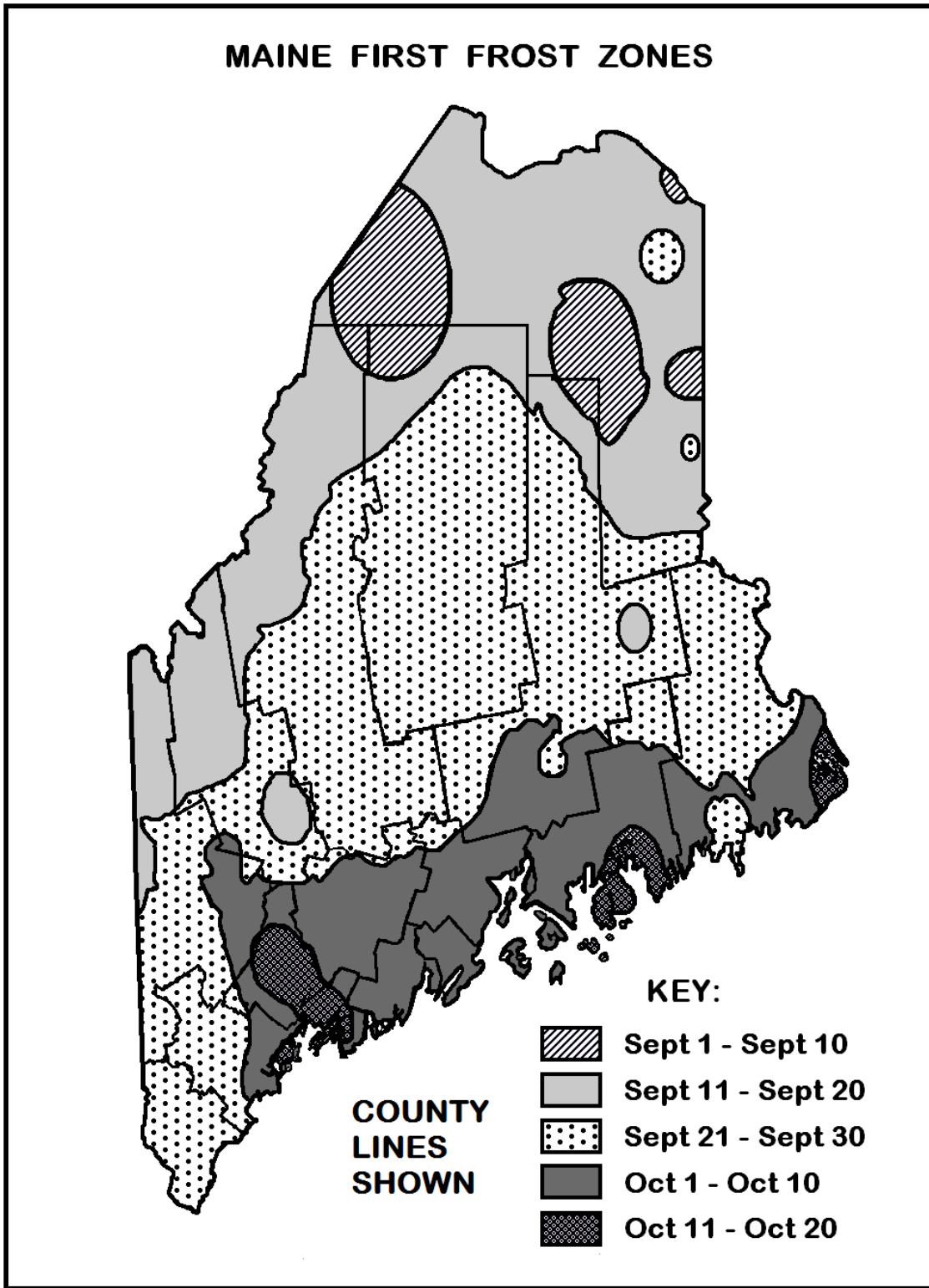

4. SODDING

Sodding provides an instantaneous cover of turf. Locations particularly well suited to sod are waterways, the areas around drop inlets in grassed swales, or where immediate aesthetic results are needed.

CONSTRUCTION SPECIFICATIONS

- The soil should be loosened to 1-inch depth, dampened and amended with lime and fertilizer if necessary.
- Follow the supplier's guidelines for installation.
- Lay sod in staggered rows (in strips perpendicular to the direction of flow). Wedge the edges of each strip together and tamp.
- Anchor on slopes to hold the sod until secured by plant growth.
- Sod should not be laid on dry soil. Irrigate sodded areas immediately and as necessary to maintain moisture below the root zone.
- Installation should be completed before runoff is directed to an area handling concentrated flows.



5. HYDROSEEDING

When hydroseeding, apply the seeds uniformly and per applicator's guidance (10% increase in seeding rate is recommended).



F. SLOPES

To be effective, slope stabilization and reinforcement should be adapted to the soil type, angle and length of the slope, presence of surface or groundwater, depth to bedrock, etc. Consultation with a civil engineer is advised for slopes that are over six feet, steeper than 1.5:1 grade, on unstable soils, with groundwater seeps, or where a structure is located near the top of the bank. A proper permit and design may be required for an embankment repair near a waterbody.

COMPANIONS: *Riprap, mulching, sediment barriers and vegetation*

Approximate slope conversions		
Percent Slope	Slope Ratio	Degrees
100%	1:1	45°
50%	2:1	27°
33%	3:1	16°
25%	4:1	12°
10%	10:1	5°

ENGINEERING DESIGN

- Surface water should be diverted away from the face of cuts and fills unless the slope will not be subject to any surface runoff or any concentration of flows.
- **Reverse slope benches** or cross-slope diversions can be provided whenever the height of a steep (greater than 2:1) slope exceeds 20 feet (30 feet for 3:1 slopes and 40 feet 4:1 slopes). Benches with a 2-3% gradient and a minimum depth of 12 inches should convey the water to a discharge point that is no further than 800 feet away. Soils, seeps, rock outcrops, etc. should be considered when planning for a bench.
- A **subsurface drainage** layer can intercept groundwater seepage that could affect the stability of a slope, create a wet soil condition or cause **shallow sloughing** (on south facing slopes in silty and clayey soils). The soil should be removed by 12-18 inches (the depth of the slough), and filled with 6 inches of bank run gravel covered with one foot of riprap (3-6 inch minimum size). Non-woven geotextile may be substituted for the gravel. Unplanned seeps or springs encountered during construction must be handled accordingly.
- **Fill slopes** should not be created so close to a property line that may endanger the adjoining property.
- All fills should be **compacted in layers**, not exceeding 8 inches, to reduce slippage, settlement, subsidence or other related problems. Fill intended to support buildings, structures and conduits, etc., should be compacted in accordance with engineering requirements and codes.
- Except for approved landfills or non-structural fills, **fill material** should be free of brush, rubbish, rocks, logs, stumps, building debris, and other objectionable materials that would interfere with or prevent compaction. Frozen material or soft, mucky or highly compressible materials should not be incorporated into fill slopes or structural fills.
- Fill should not be placed on a **frozen foundation** without proper scarification.



Seeping slopes are found at cuts that intercept the groundwater table. Often, riprap over a layer of drainage gravel is the only appropriate stabilization measure.



Slopes that will be revegetated should be no steeper than 2:1. Where the slope is to be mowed, the slope should be no steeper than 3:1 (4:1 is preferred for larger mowing equipment).



Soft sedimentary rock can be modified to create a surface for vegetation growth when the rock is rippable and can be shelved. The shelves will hold moisture, seed, and mulch.



Sloughing slopes are caused by freeze/thaw cycles in silty and clayey soils, or from groundwater seeps in a loamy soil found over a shallow hard pan. On short slopes, the bank should be over-excavated and filled with 6 inches of gravel and provided with an appropriate surface cover. On steep slopes, a structural measure will be necessary.



Groundwater drains, soil reinforcement or even a retaining wall may be necessary where the slope is failing due to groundwater seepage or soil instability.

1. CUTS AND FILLS

Erosion potentials on fill slopes depend upon the depth of the fill, steepness, watershed size and presence of water. Fill slopes are more unstable than cut slopes from being disturbed or if lacking fines for proper compaction. In a wet area, gravel fill is preferred; but is at risk of being unstable. Terracing prevents surface runoff and promotes vegetation establishment by retaining moisture.

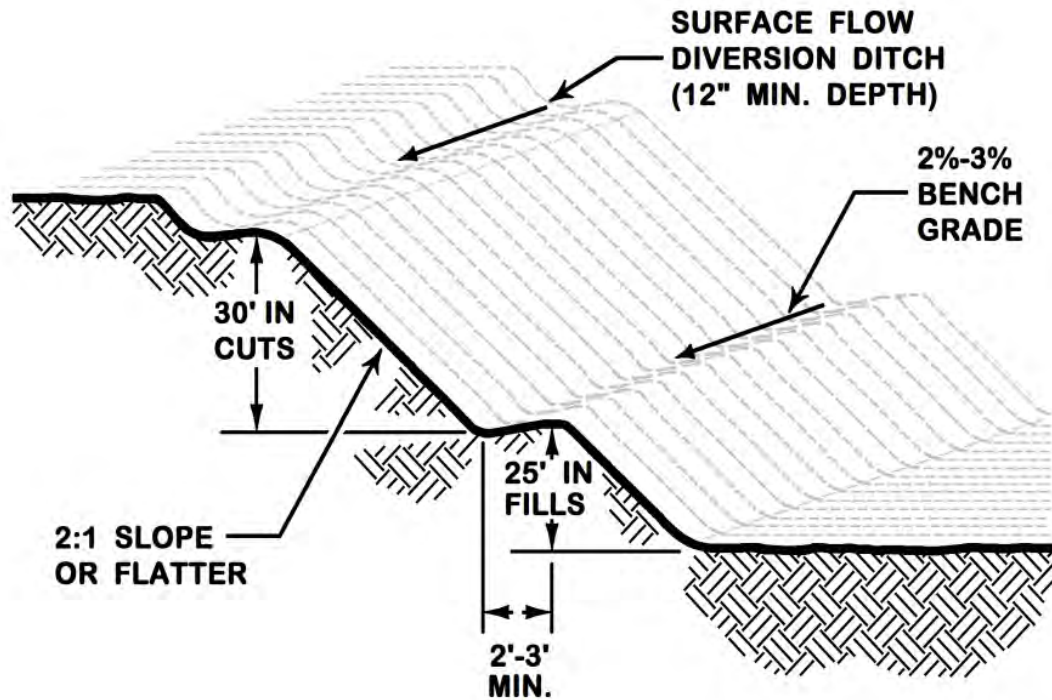

Terraces are benches across a slope that interrupt runoff and promote infiltration. The benches redirect the runoff and reduce erosion.

CONSTRUCTION SPECIFICATIONS

- The time between initial exposure and final stabilization should be minimized to prevent soil loss.
- Divert clean water away from the area and disperse to an undisturbed buffer or swale.
- For a fill slope, the native area should be cleared, grubbed, and scarified to a 3-inch depth. When working in below freezing temperatures, the ground should be scarified immediately before adding fill.
- The fill should be free of brush, rocks, or roots, and should not include frozen, soft or mucky material.
- The fill should be placed and compacted in 8-inch lifts to reduce lenses of loose soil.
- When filling or cutting a long slope (greater than 20 feet), benches (or terraces) should be provided to direct runoff away from the slope. The number of benches should be based upon the erodibility of the soil, steepness of the slope, and groundwater seeps.
- Mulch any soil exposed for longer than 7 days and with seed if ready for revegetation.
- Rill or gully erosion should be repaired immediately.
- Use winter stabilization practices if the construction is stopped for the winter months.

2. GEOTEXTILES

Geotextile filter fabric is a permeable, synthetic material that is used as a separation or reinforcement between different soils or rock layers while retaining the soil and allowing water to pass. There are many types of geotextiles and the manufacturer or vendor should be consulted before selecting a material for the intended use.

Geotextiles should be placed with 12 inch overlaps and keyed 6 to 12 inches at the top and bottom of the area. Avoid using damaged cloth.

WOVEN GEOTEXTILES are mostly used for soil reinforcement beneath sharp, angular aggregates if dropped more than 5 feet; and where the cover will be more than 10 feet thick. It may be used for seepage management if the fabric's openings are smaller than the soil gradation. A woven filter fabric is usually used in a road base to provide bearing capacity and linear strength over soft subsoil.

NONWOVEN GEOTEXTILES will retain more fine particles than woven geotextiles; and may allow water seepage without clogging. Nonwoven geotextiles have a rough surface that will bond soil layers and resists sliding along the planes of contact.

ENGINEERING DESIGN

- A geotextile fabric can **separate** different soil layers and prevent underlying soil from eroding away under riprap; it can filter out fines that can clog a drainage pipe or drainage layer; and it can **reinforce** a soil or provide stress distribution within the soil structure.
- The **soil surface** should be relatively smooth and free of protruding rocks and debris that can puncture and tear the fabric.
- A **non-woven geotextile** is very permeable, will better conform to the soil surface, and will prevent soil erosion beneath riprap.
- **Cushion a fabric** with gravel to provide sun protection, and minimize voids under riprap. Pushing or rolling rock over a geotextile should not be allowed (maximum drop is 3 feet). Where a higher drop is necessary, the strength of the geotextile and/or thickness of the cushioning material should be increased. The tensile strength should be no less than 150 pounds and burst strength no less than 300 psi.
- **On a slope**, overlap multiple sheets of geotextile by 1-2 feet (upslope fabric overlapping the downslope fabric like shingles on a roof). The geotextile should be pulled flat during installation to eliminate wrinkles and folds that cause voids. Key the geotextile at the top and bottom of the area to prevent riling beneath the fabric. Cutoffs should be more closely spaced in highly erodible soils than in stable soils.

3. RIPRAP PROTECTION

Riprap is used for structural support when a slope cannot be vegetated due to length or steepness of the slope, groundwater or surface water seepage, poor soil conditions, flowing water, etc. On a long slope, larger stones are used and placed at the bottom of the embankment and gradually grading down to smaller stones toward the top. A riprap stabilization project is composed of three sections:

- The surface armor layer of rough, angular rocks.
- The filter layer (a sand and gravel layer and/or a geotextile fabric) that supports the stones against settlement, allows groundwater to drain through the structure, and prevents the soil beneath from being washed through the riprap layer.
- The toe protection that reinforce the slope and prevents movement of the riprap. It is usually anchored in a trench at the toe of the slope.

IMPORTANT NOTE

The riprap should be well graded with an average stone size described as the D_{50} which refers to the diameter of stone for which 50% of rocks will be smaller and 50% will be larger. This allows for a mixture composed primarily of the larger stone sizes; but with a sufficient number of the small rocks that fill the voids. The diameter of the largest stone size in such a mixture should be 1.5 times the D_{50} size. Refer to *Maine DOT specifications for more information on standard types of riprap*. At times, it may be difficult to obtain a rock mix with a specific D_{50} gradation. In these cases, use stones large enough so water or gravity won't move them and fill the voids with smaller rocks.

CONSTRUCTION SPECIFICATIONS

- Any fill material should be well graded and should be compacted to a density approximating that of the undisturbed material nearby, or to 95% Standard Proctor density compaction.
- Entrench the toe of the riprap for structural support and use larger rocks.
- If a drainage layer is necessary to control groundwater seepage, approximately 6 inches of granular fill should be spread uniformly over the native soils. A nonwoven geotextile filter fabric may be placed directly on the prepared slope in situations where groundwater is not an issue. For more protection, provide both the drainage layer and the geotextile. The permeability of the filter fabric should be higher than the native material for the seepage to pass freely.
- When large stones are used for surface armoring (12 inches or greater), provide a 3-4-inch layer of gravel ($\frac{3}{4}$ inch washed stone) to distribute the load, protect the fabric from degradation and to provide interfacial contact.
- The riprap should never be layered nor dumped, as the various stone sizes may get segregated or the underlying material disturbed. Final hand placement may be necessary to achieve grading.

STONE QUALITY: The stones in riprap should be chemically stable, hard, angular field stones or rough unhewn quarry stones which will not disintegrate by weathering or exposure to water. Rubble concrete may be used provided it has a density of at least 150 pounds per cubic foot. Round river rocks may be appropriate in situations where the slope is shallower than 3:1, in a channel that has no concentrated water flow, and people will not access the area.

FILTER BLANKET: A nonwoven geotextile fabric covered with 3 inches of gravel should be provided to protect the fabric and prevent slippage of the overlaying rocks.

DRAINAGE LAYER: A 6-inch layer of clean drainage sand (MaineDOT Type C underdrain), clean gravel or pea stone should be placed between the geotextile and the underlying soil surface for the drainage of groundwater if the stability of the slope and its riprap cover is at risk from the pore pressure.

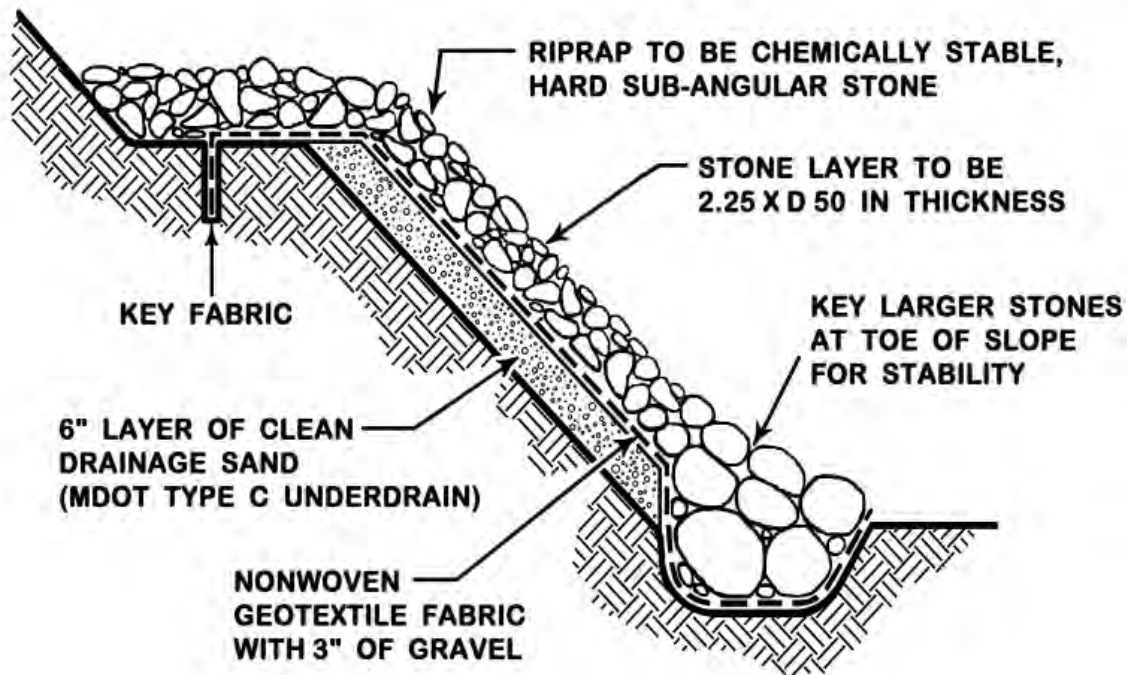

To be a permanent, erosion-resistant cover, riprap should contain large, angular stones with a variety of sizes that will provide a cohesive, strong and well blended cover with minimum voids. The desired distribution of stones may be obtained by selective hand placing.



Include inter-planting when near a water body or allow for revegetation. Willows and dogwoods work best.



The time between initial exposure and final stabilization should be minimized to prevent soil loss. And regularly inspect the slope and after severe storms for slumping, sliding, or seepage problems. The sides of the riprapped area may be prone to instability or erosion. Correct any problem immediately.



Minimum thickness of a riprap layer should be at least 6 inches or twice the median rock size in the riprap whichever is greater.



Slopes steeper than 1.5:1 or longer than 6 feet should be engineered.



Regularly inspect the slope for slumping, especially after severe storms, sliding, and seepage problems. The sides of the riprapped area may be prone to instability or erosion. Correct any problem immediately.

4. GABIONS

A gabion wall is made of stacked flexible woven-wire baskets filled with rocks to form a homogeneous revetment or retaining wall that will provide structural strength to a slope with loose soils or groundwater seeps. A major advantage of gabions over riprap is that smaller stones may be used making handling easier.

CONSTRUCTION SPECIFICATIONS

- A granular filter and geotextile fabric should be provided behind the gabion baskets to provide for groundwater seepage.
- The rock used to fill the gabions should be larger than the gabion mesh opening.
- Care should be taken when placing aggregates to ensure that the sheathing on PVC coated gabions is not broken or damaged.
- After filling, the lid should be secured to all sides with connecting wire.
- To ensure long-term effectiveness, periodic inspection for signs of undercutting or excessive erosion at all transition areas is essential. Repairs should be carried out promptly.

ENGINEERING DESIGN

- **Plastic coated gabions** should be used if the local soil or water pH are below 5, and resistivity is more than 4,000 ohms/cm. Do not break or damage the sheathing when placing aggregates.
- The Manning's "**n**" value for gabions should be 0.025.
- The **rock fill** in gabions should be larger than the gabion mesh opening.
- A **base bedding** of gravel or non-woven geotextile fabric is necessary to a gabion wall. The gravel should be sized relative to the D₅₀ of the rocks.
- The **maximum velocity of flowing water** in a channel lined with gabions should not exceed the following: 6ft/sec flow velocity for a 6-inch thick gabion mattress, 11ft/sec flow for an 8-inch mattress and 14ft/sec for a 12-inch gabion mattress.
- Gabions should not be exposed to the **abrasion from sand or gravel** in moving water.
- **Along a stream**, vegetation should be included in the gabion wall to shade the stones.



A gabion wall should be designed according to the manufacturer's specifications.

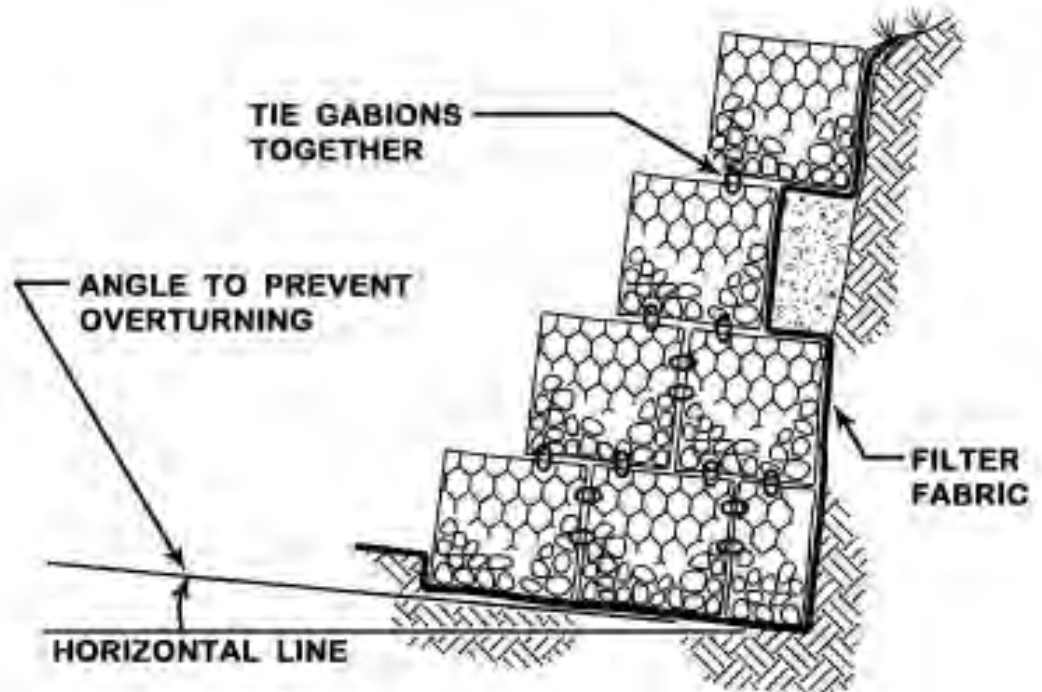

ROCK GABION WALL

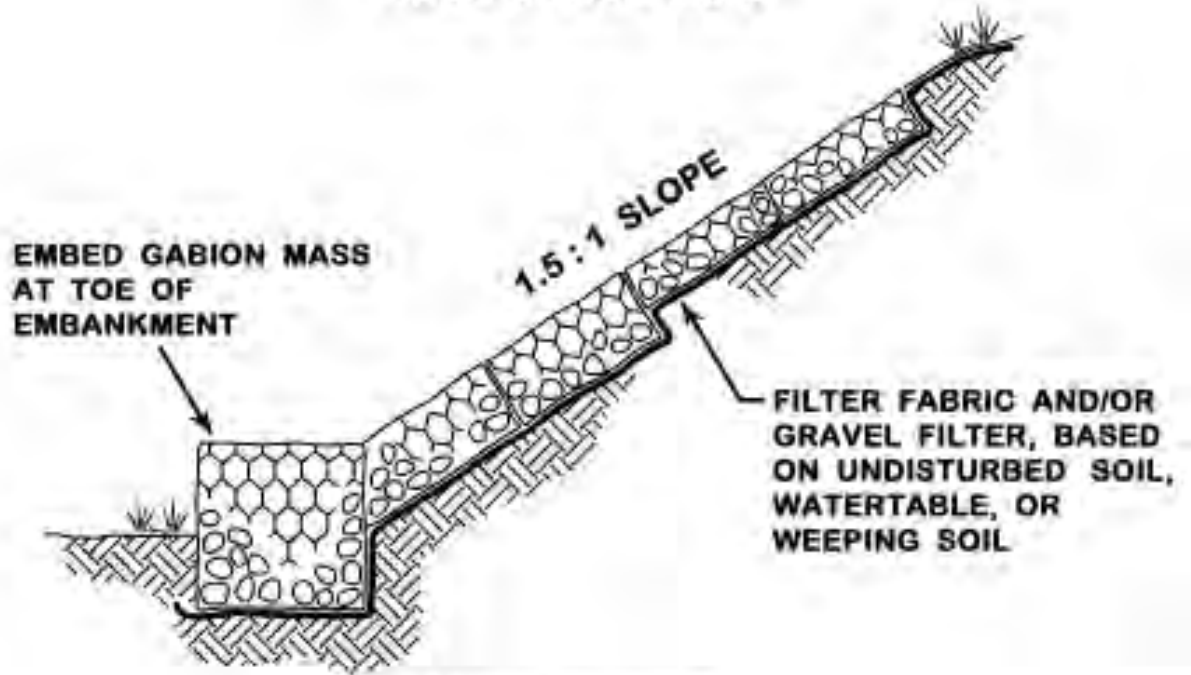

GABION MATTRESS

5. TURF-REINFORCED MATTING (TRM)

Turf reinforced matting is a reinforcement of permeable, synthetic, three-dimensional rigid or flexible geotextile product that permanently strengthens the soil surface, supports vegetation where it may not thrive (steep and erosive slopes or channels with high water flows). These products can replace riprap while allowing for revegetation and providing structural support; but they should be designed, specified and installed in accordance with the manufacturer's specifications.

CONSTRUCTION SPECIFICATIONS

- Turf-reinforced matting is designed to work with vegetation, but needs to be inspected and maintained to insure stability of the matting.
- Anchoring and filling with a good quality-topsoil is key for the performance of these mats.
- Seeding and mulch may be required over the mat.
- Inspect the area for erosion until vegetation has a full catch of grass (90%) and repair.

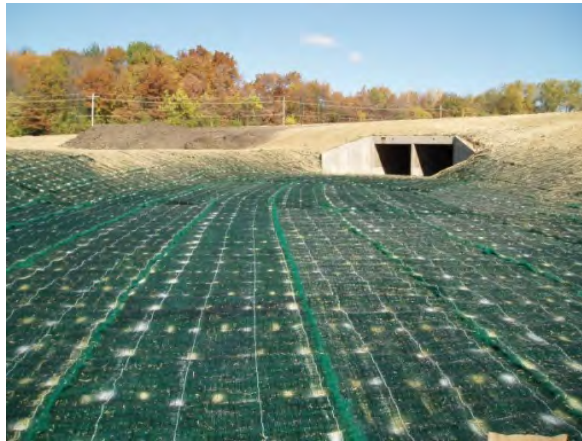

6. CELLULAR CONFINEMENT SYSTEMS

Cellular confinement systems (geo-webs) are made of a geo-synthetic material structured to retain soil, aggregate or concrete within its cellular shape. The cellular confinement structure retains a large volume of soil which provides weight and shear resistance from its interlocked matrix while allowing vegetation growth on steep slopes. It provides immediate slope stabilization through its three dimensional structure for abutment protection, containment dikes and steep slopes. The geo-web layer should have a solid soil base for fastening, or it may be unsuitable on rocky slopes. Once anchored to the slope and backfilled with topsoil, the system replaces riprap and will sustain a vegetative cover. The manufacturer should be consulted for the selection, design and installation of this product.

CONSTRUCTION SPECIFICATIONS

- Use on slopes with a 1:1 grade or less.
- An engineered design and slope stability assessment is recommended.
- Seeding and mulch is usually required over the mat unless it is used as reinforcement for a gravel surface (boat launch, gravel parking, retaining wall, etc.).
- Geo-webs may be used in a stream or channel flow. Planting or incorporation of vegetation should be considered for the water depth and velocity on the channel.



7. SLOPE DRAINS

A slope drain is a stabilized conduit or channel that contains runoff down the face of a slope and to a stable discharge point. When used in conjunction with a diversion dike, a slope drain can redirect stormwater and prevent rill and gully erosion over an embankment. It can be a temporary or a permanent structure.

ENGINEERING DESIGN

- The **maximum drainage area** of a slope drain should be small (less than 5 acres) and should be sized according to the following:

Drainage Area (acres)	Pipe Diameter or equivalent channel sizing (inches)
0.5	12
1.5	18
2.5	21
3.5	24
5.0	30

- The **inlet to a piped slope drain** should include a standard flared end-section for metal pipe culverts (MaineDOT specs) with watertight fittings. Extension collars (corrugated metal pipe) should be sized appropriately or be a minimum of 12 inch.
- The diversion berm at the inlet should be 6 inches higher than the anticipated flow in the channel.
- The **flow inlets** should slope toward the slope drain at 1/2 inch per foot minimum and should be hand-tamped in 8-inch lifts to prevent piping failure around the inlet.

CONSTRUCTION SPECIFICATIONS

- As a temporary measure, the slope drain may consist of a heavy-duty flexible pipe or a constructed channel lined with plastic. A pipe should be at least 12 inches if used for more than one day. A permanent structure should be either revegetated or rippapped.
- A water diversion should direct the runoff to the drain at the top of the slope; and at the outlet of the diversion, a plunge pool or a level spreader are needed for a stable discharge.
- All connections should be secured to the slope (anchored or bermed) and watertight.

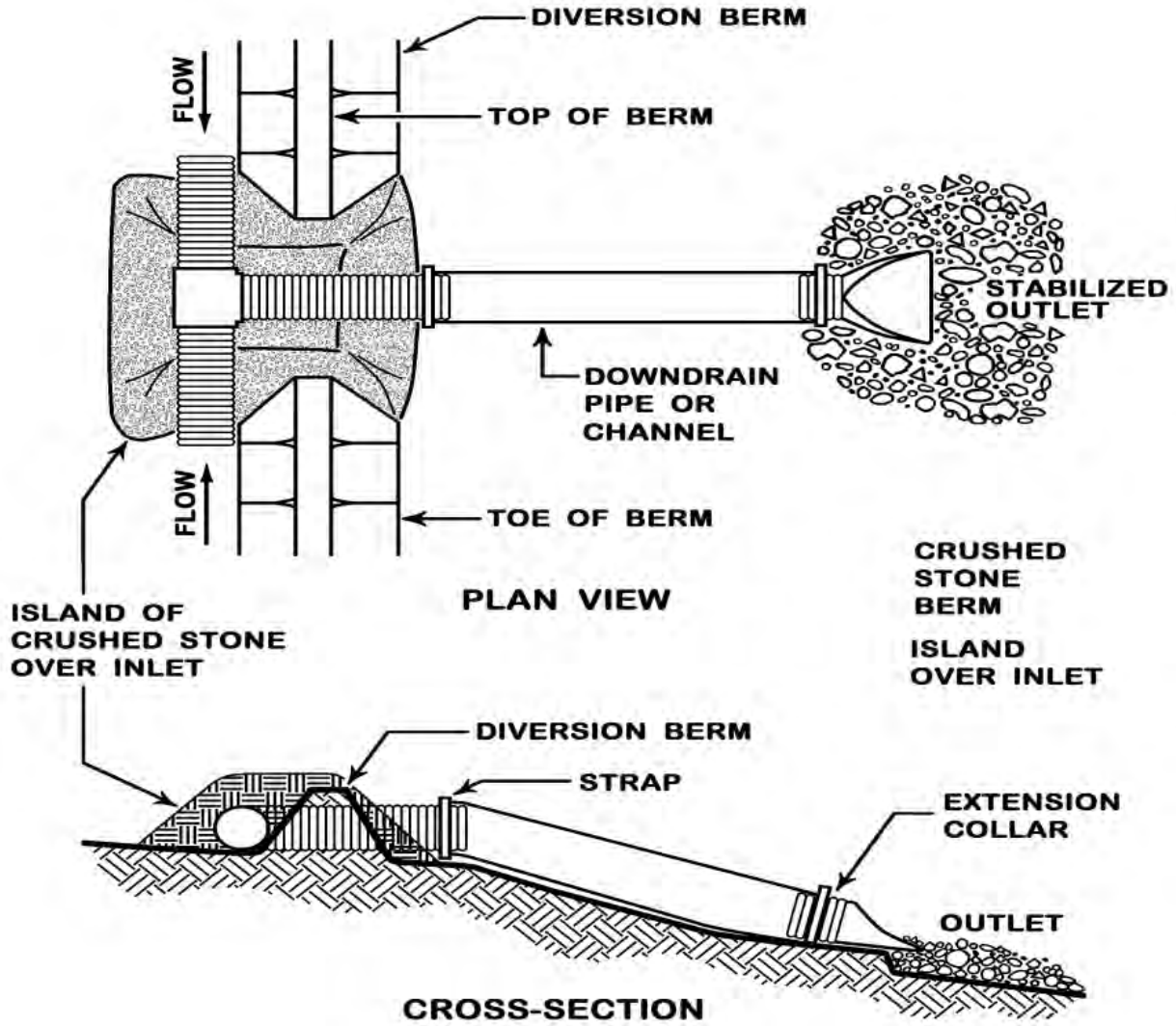

The slope drain should be located on undisturbed soil or well-compacted fill. Upon stabilization of the slope, a temporary slope drain can be removed.



The slope drain structure should be inspected daily and during every storm event. The structure should be kept clear of sediment and debris.

G. SWALES AND DITCHES

Swales and ditches concentrate and direct runoff to an appropriate discharge point with the water flowing smoothly and without overtopping the channel's banks. In a stable condition, the channel should have a parabolic or trapezoidal shape (as a U-shape and not a V-shape), be graded and preferably stabilized with vegetation. Riprap or other structural method should be used for high flows, steep grades or on poor soils where vegetation is not possible. New stabilization options such as turf reinforcement mats can provide structural stability on marginal sites for vegetation; but the manufacturer should be consulted for guidance.

COMPANIONS: *Streams, Roads, Mulching, Sediment Barriers, Vegetation*

Channel Stabilization		
Channel Grade	<5 Acre Watershed	5-10 Acre Watershed
0.5 - 3%	Seed & mulch*	Seed & mulch *
3 - 5%	Seed & erosion control blanket *	Seed & erosion control blanket *
5 - 8%	Seed & erosion control blanket *	Line with 2.25 times D ₅₀ riprap
8 - 20%	Line with 2.25 times D ₅₀ riprap	Site specific engineered design
*If the bottom of the channel is above the groundwater table		

CONSTRUCTION SPECIFICATIONS

- Once the soil within the channel is exposed, it should be shaped, graded and stabilized immediately. Construct a channel in sections from the bottom up.
- Any water in the channel should be diverted during construction.
- To maintain its capacity, the channel should be over-excavated to allow for the thickness of the stabilization measure (up to 18 inches for riprap). A channel's cross-section should have a broad interior with a 2:1 maximum side slopes.
- The channel should be shaped and compacted for a smooth and uniform surface. Any required fill should be compacted to the density of the surrounding soils, or to a 95% compaction as determined by Standard Proctor.
- In areas of high flows, poor soil conditions or high groundwater, a filter fabric or a bed of gravel should be provided to prevent the migration of fines from the subbase.

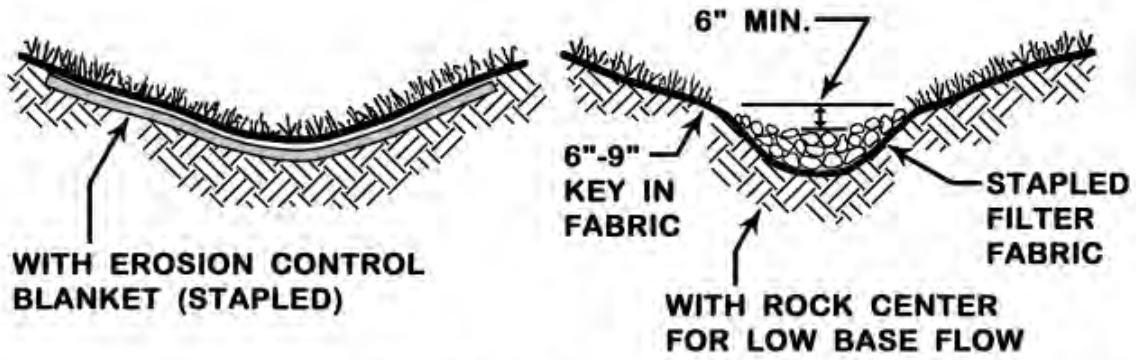

PARABOLIC CHANNEL

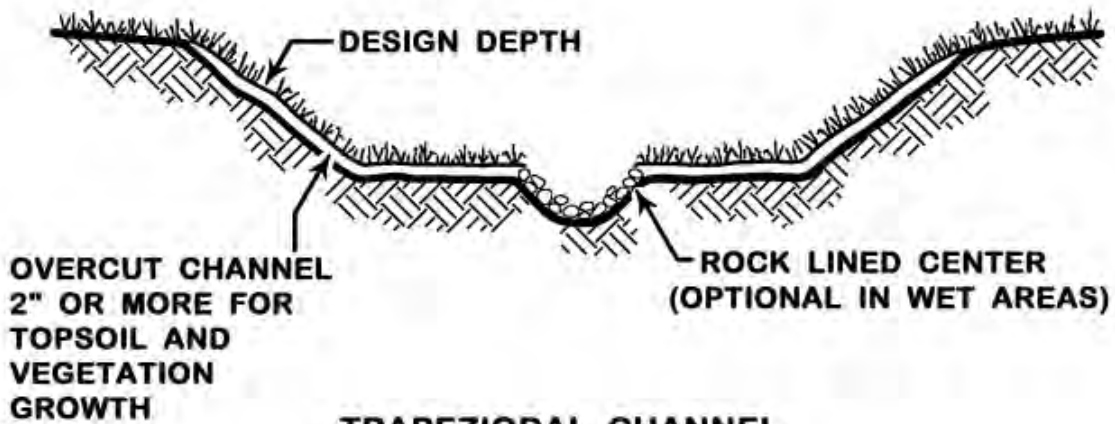

TRAPEZIODAL CHANNEL

During construction inspect the channel daily and during storm events to check for erosion. Repair as needed. After the channel is stabilized, maintain a channel that is stable and free of debris. Vegetated swales need to be stabilized early during the growing season (by September 15) or be protected with an erosion control blanket or riprap.



1. VEGETATED CHANNELS

A vegetated waterway (roadside ditch, drainage swale, etc.) should be shaped or graded with a parabolic or trapezoidal cross-section and stabilized with healthy vegetation to prevent down cutting and channel migration.

CONSTRUCTION SPECIFICATIONS

- Unless structural support is needed, mix loam into the swale bottom and sides.
- Upon final grading, the disturbed areas should be seeded and mulched. Hay mulch is not appropriate in steep channels (greater than 5 % grade) with high flows. A strip of erosion control blanket at the base of the swale can protect the structure until vegetation is established. Follow the manufacturer's specifications for stapling.
- The bottom of a vegetated ditch with continuous flow, a high water table, or seepage problems can be protected with stones (2-3 inches thick) or other reinforcement.
- Inspect a vegetated channel regularly during construction and in the spring and fall afterwards. Remove debris and repair.
- Mow vegetated ditches and swales no later than 30 days prior to the first killing frost and to a minimum height of 4 inches.

ENGINEERING DESIGN

- A swale should contain the **peak runoff** from a 24-hour, 10-year storm with the discharge flowing smoothly and without overtopping or velocity increase.
- **Velocities** should not exceed the velocity for vegetated soils as listed in Appendix C.
- A **channel on a slope greater than 8%** and with concentrated flows or groundwater seepage will not hold vegetation. It should have a riprap center or another suitable reinforcement measure.
- Sites with slopes less than 2% and with high groundwater or seepage should be revegetated with a **wetland vegetation** mix if appropriate.
- On flat slopes (2% or less), **out-of-bank flow** is acceptable if flooding will not cause erosion or property damage.
- The placement of one strip of **erosion control blanket** at the base of a channel with a slope that is less than 8% can protect the swale bottom from erosion until vegetation is established. Adequate stapling and anchoring is necessary.

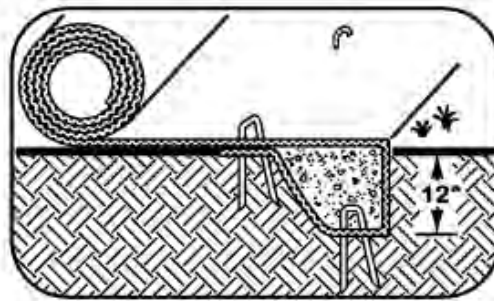
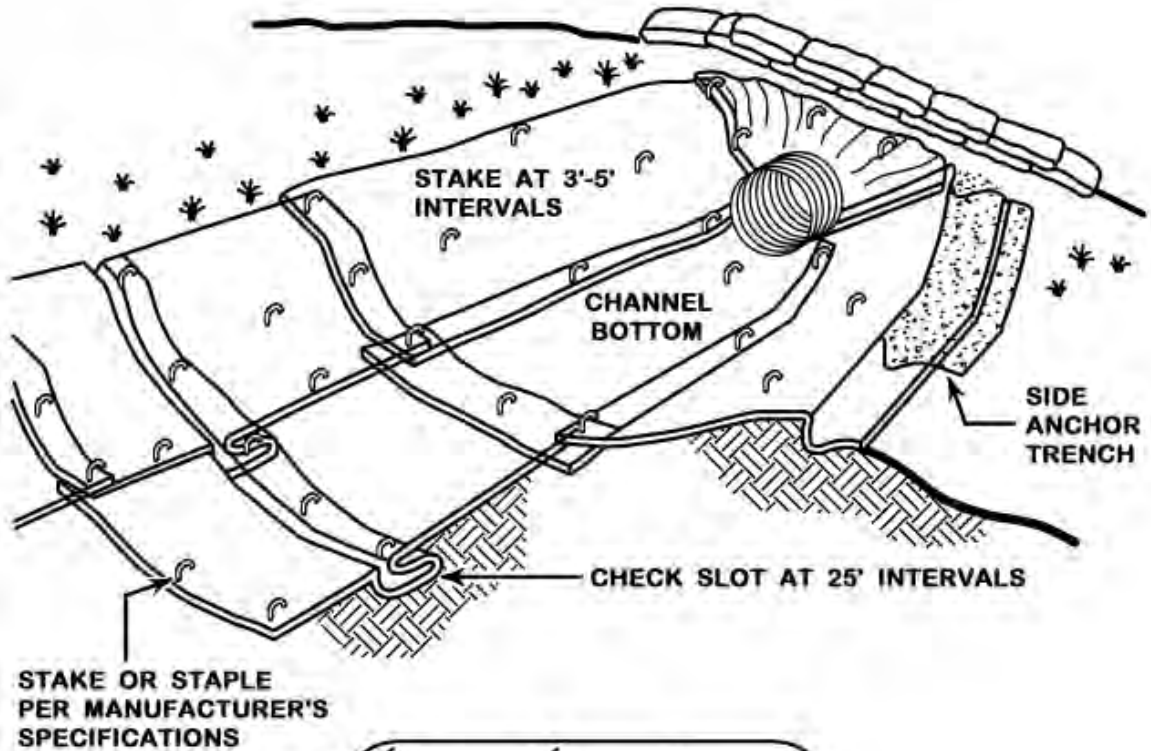

TOP ANCHOR TRENCH DETAIL



2. RIPRAP CHANNEL

Riprap will protect a swale or ditch that is on a steep grade, is on erodible soils or has continuous high flows that will not allow for vegetation growth. Riprap can stabilize ditches with seepage problems and it will slow the velocity of flow. It should be sized for the maximum anticipated flow depth within the channel as follows:

RIPRAP SIZING DIAMETER (D50)					
		CHANNEL SLOPE			
		1%-2%	2%-5%	5%-10%	10%-20%
MAXIMUM DEPTH OF FLOW (feet)	<0.5	3"	4"	4-6"	6-12"
	1.0	3"	6"	6-12"	12-18"
	2.0	4-6"	6-12"	12-18"	18-24"
	>3.0	6-12"	6-18"	18-24"	24"

ENGINEERING DESIGN

- **Flow velocity** can be reduced by the friction that occurs along the flow channel. For riprap, n for Manning's equation is calculated as follow:

$$n = \frac{y^{1/8}}{[21.6 \log_{10}(y/D_{50}) + 14.0]}$$

where: y = depth of water in feet

D₅₀ = riprap diameter in feet

The **riprap size** can be established for the velocity within the channel as follow (from USDA Soil Conservation Service):

FLOW VELOCITY (fps)	RIPRAP D₅₀ (inch)
16	36
13	24
11	18
10	15
8	10
6	6
4	3

- **Riprap selection** should be based on a gradation that will exceed the size calculated to be stable under anticipated flows. The bulk specific gravity (saturated surface-dry basis) of the individual stones should be at least 2.5.
- A **filter blanket** should be placed between the riprap and the underlying soil surface to prevent soil movement into or through the riprap. It may be a geotextile fabric or a sand/gravel layer sized for the gradation of the riprap and the base material.
- **Over-excavation** of the subgrade is necessary for the riprap and/or filter to maintain channel capacity.
- Any **fill** in the subgrade should be compacted to a density equivalent to the surrounding undisturbed soils, or to 95% Standard Proctor density compaction.

CONSTRUCTION SPECIFICATIONS

- Over-excavating the swale to accommodate the depth of the riprap layer is necessary, to have the riprap surface at the swale surface, and to maintain full capacity of the swale.
- A filter of geotextile fabric (anchored per the manufacturer's guidelines) should be placed between the riprap and the natural soil surface if soil loss into or through the riprap is a concern.
- The riprap should be placed so that it produces a dense mass of stone with a minimum of voids. The riprap should consist of hard sub-angular large stones.
- To provide adequate coverage, the minimum thickness of the riprap layer should be no less than 8 inches or twice the D_{50} stone diameter.

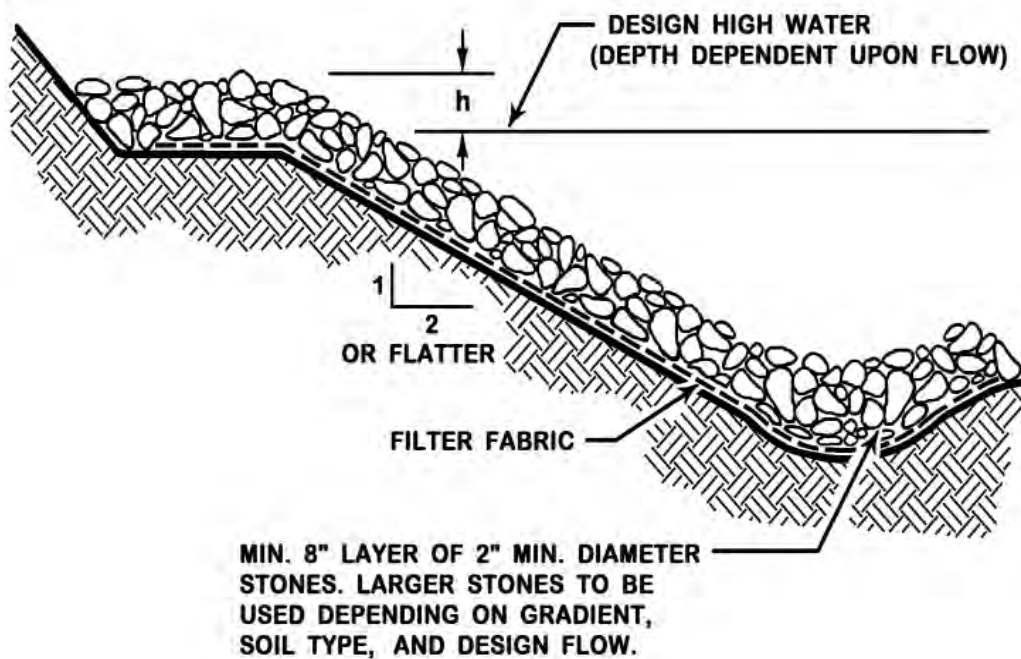

The riprap should extend across the bottom and up both banks of the channel to the maximum height of flow or to a point where vegetation can be established.

3. TURF REINFORCEMENT MAT

Turf reinforcement mat (TRM) is a mesh-like product composed of non-degradable synthetic fibers, filaments, nets, or wire mesh that provide reinforcement and structural support to slopes or channels that will be revegetated. TRM mats may also replace riprap when not available or too costly to transport. Consult with an engineer for design specifics and follow the manufacturer's specifications for installation.

CONSTRUCTION SPECIFICATIONS

- Scarify and roughen the prepared surface. Remove rocks and debris which may prevent good contact between the mat and the soil surface.
- Staple per manufacturer's specifications - Do not under-staple!
- Rake topsoil (4" minimum) over the TRM to insure interlocking of the material. Seed and mulch.
- Add more topsoil if the fabric is showing through.
- Mowing over an area with any apparent netting or fabric may rip and destroy the matting.

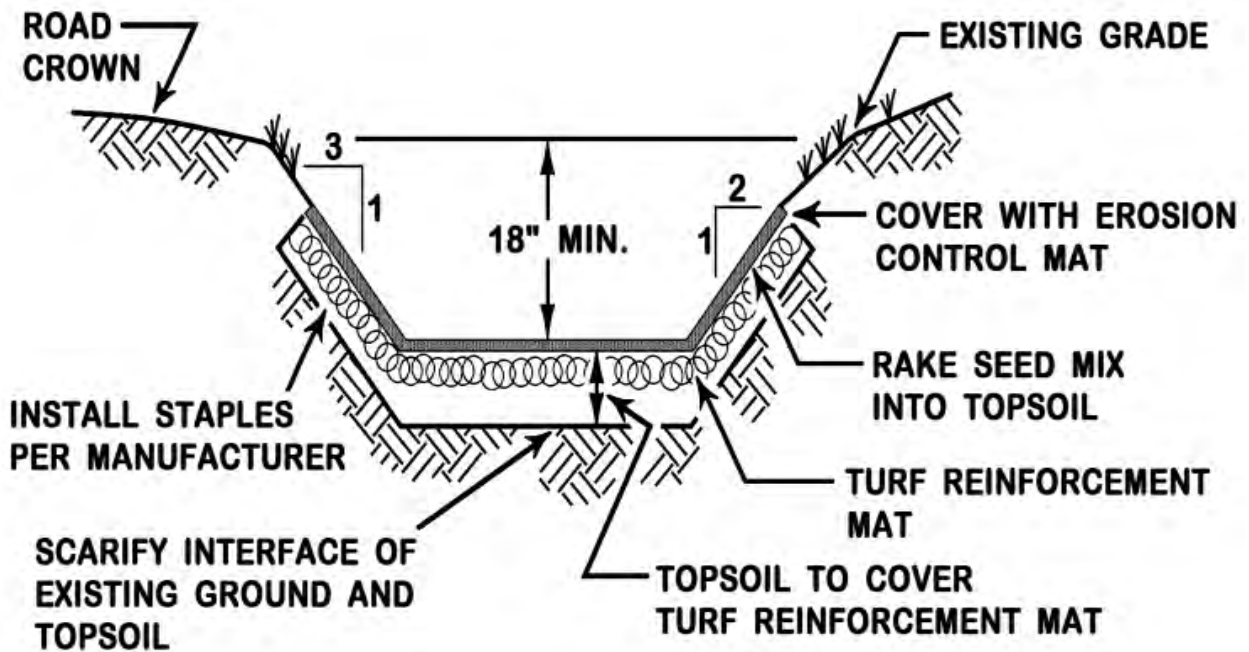

4. LEVEL SPREADERS

A level spreader is a discharge outlet to disperse or spread runoff flows thinly (as sheet flow) across the slope and over a buffer to promote infiltration and to prevent channelization. The lip of the level spreader should be installed as level as possible to ensure a uniform distribution of flow and should blend smoothly into the downstream receiving area. This practice should not be used where an upgradient drainage area is greater than 10 acres, where the discharge is within 25 feet from a stream, or if the discharge crosses into an adjoining property.

Stone can be used to create a level spreader with the advantage that the top of the spreader does not need to be level, as any water flowing through the voids between the rocks will sheet flow out of the spreader.

CONSTRUCTION SPECIFICATIONS

- When discharging to a forested buffer, the receiving area should remain undisturbed, have a duff layer, and have an even topography but without channelization that could concentrate runoff. A spreader should be located away from a stream or wetland.
- If revegetation of the receiving area is necessary, construction should be limited to the growing season (before September 1st). No water should be directed to the spreader before vegetation has reached 90% coverage and a temporary stormwater diversion may be needed.
- The lip of the level spreader should be installed on the contour to ensure a uniform distribution of flows or should consist of crushed rock (1"-3" stone is recommended) placed on the undisturbed part of the level lip to promote sheet flow and reduce velocity.
- The entry angle from the channel to the level spreader should be no greater than 30 degrees to prevent scour and short circuiting.

ENGINEERING DESIGN

- The **capacity** of a level spreader should be based on the allowable velocity of the soil (APPENDIX C) and should be sized to transfer 0.25 cfs per linear foot of spreader during the peak flow of a 24-hour, 10-year storm event.
- The **lip of a level spreader** should be level (0% grade) for a uniform flow distribution; otherwise water may channelize and erode a channel. A compacted berm topped with 6-12 inches of crushed aggregate may be most successful at maintain a level lip.
- The **receiving area** should have an even topography to prevent flow concentration. Sheet flow below a spreader is expected to re-concentrate within 300 feet. Evaluate the slope, soils and vegetative cover of the receiving area before designing a level spreader.
- The **buffer area** below a level spreader should remain undisturbed and with healthy vegetation. If the receiving area needs to be re-established, its final stabilization should occur before September 1 and before large volumes of water is directed to the spreader.
- The **capacity of the level spreader** should be equal to four times the capacity of the delivery channel for a low approach velocity.
- The spreader should be constructed from the uphill side.



The length of a level spreader should be based on the expected runoff volume and slope of the receiving buffer. Typically, a spreader should be no smaller than 12 feet.

Level spreaders should be constructed on undisturbed soil from the uphill side. The buffer and area below the spreader should remain uncompacted from construction equipment.

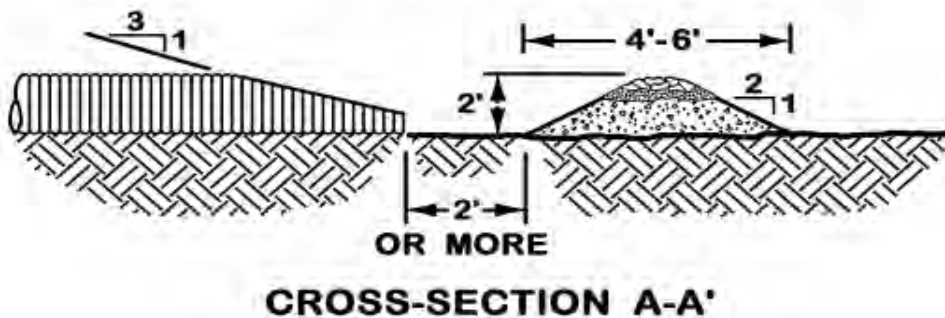
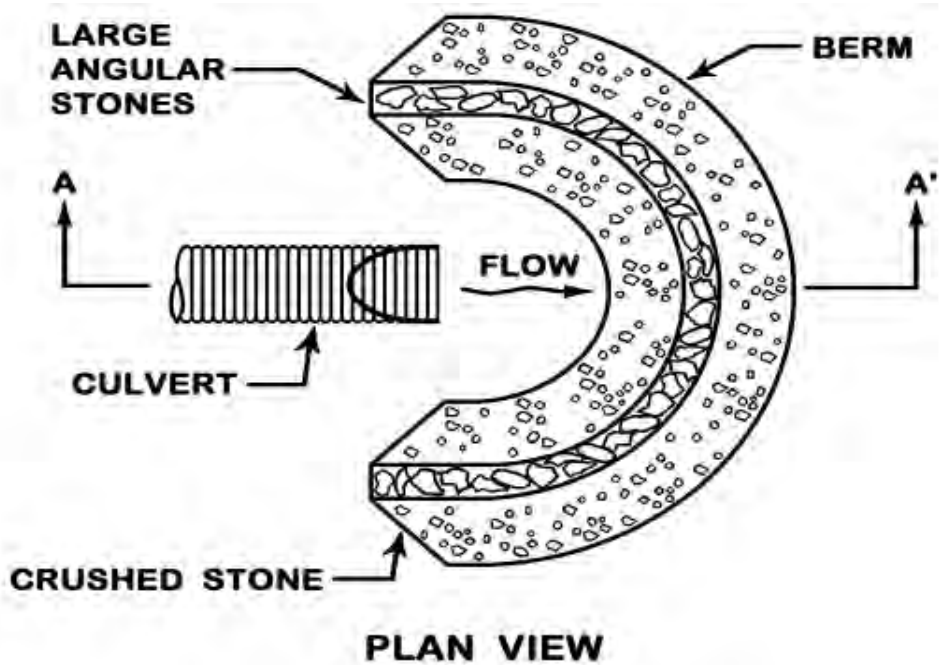

H. CROSS CULVERTS

A culvert for a road crossing should be sized and installed correctly to prevent erosion or flooding. This guidance is only intended for the installation and stabilization of small culverts (driveways and small road crossings), and someone with expertise should be consulted for the crossing of a stream or for a pipe larger than 36 inches. The installation of any pipe (plastic, concrete, aluminum, steel, etc.) should also meet the requirements specified by the manufacturer.

COMPANIONS: *Swales and Ditches, Streams, Roads, Mulching, Sediment Barriers, and Rock Sandwiches*

NEW CULVERTS: Many variables affect a new culvert (size of drainage area, depth and width of channel, soil types, elevation of road, length of culvert, etc.) and will need consideration. Unless the channel is well established and the size, slope, alignment and embedment of the culvert straight forward, consulting with a professional is recommended.

REPLACEMENT CULVERTS: A culvert to be replaced should be assessed for its current performance and capacity before considering a new pipe. Proper field determinations and measurements are necessary to ensure stability and capacity (i.e. watershed size, channel width and cross-section, alignment, length of pipe, elevation and width of the road, downgradient structures that depend upon detention, channel restrictions, etc.).

ENGINEERING DESIGN

- If the culvert is for a **stream crossing**, fish passage should be considered and a NRPA permit will be required.
- The size of the design storm should be based on state or local regulations and the sensitivity of the resource. In watersheds less than 640 acres (1 square mile), a new crossing should be designed to accommodate flows from **the 24-hour, 10-year storm event** or greater.
- All **appurtenant structures** (trash and animal guards, anti-seep collar, anti-vortex insert, etc.) should be installed promptly, and provisions made for protecting them during installation.
- **Culvert materials** (plastic, concrete, aluminum, and steel) should meet or exceed the design requirements against leakage and should withstand all internal pressures or vacuum and external loading for the conditions of the crossing. All manufacturers' design and installation standards should be followed.



The construction should be timed with a period of low or no flow to minimize a sediment discharge and it should not start if any rain event is predicted. Check the weather daily.

CONSTRUCTION SPECIFICATIONS

- If the drainage channel is offset from a perpendicular line across a road, the culvert should be longer than a direct line across the road and should extend from one side of the channel to the other. A longer culvert will be necessary.
- If the drainage pipe discharges to a naturally flat and vegetated area and not a channel, a level spreader may be necessary for the discharge to sheet flow without eroding a channel.
- The grade of the pipe should be 2% or less and daylight at the bottom of the channel or preferably below. Otherwise, a plunge pool or riprap apron should be provided.
- A culvert installed over bedrock should have appropriate bedding; or an oval or arch culvert with footings may be necessary.
- The culvert should extend beyond the fill by at least one pipe diameter and be covered with fill as thick as one pipe diameter or a headwall should be provided.
- Multiple culverts should be separated by at least 12 inches of compacted fill.
- Culvert joints should be free of any soil or debris (the pipe connection can be kept clean by over excavating). Align the two pipes and either pull together with a strap and a come-along or push with a backhoe (protect the ends from being crushed). The first pipe can be partially backfilled to provide more stability.
- Anti-seep collars should be provided to prevent undermining.
- The backfill should be compacted in 6-inch lifts beneath and around the pipe to provide support and prevent frost-heaving. Compacted lifts should continue up to the road base. The native material may be appropriate as backfill if free of large stones or high amounts of silt, clay and organic materials.
- To be revegetated, the side slopes of culvert aprons in gravelly or clayey backfills should be flatter than 2:1; and 2.5:1 in sands or silts.
- Once brought back to grade, all disturbed areas should be regraded to blend with the surrounding land features and should receive final stabilization (seed and mulch or riprap).
- Inspect a culvert in the spring and fall, and after severe storms for slumping, sliding, seepage, erosion or scouring. Repair as needed and remove debris or other material that could block or constrict the opening.



A culvert that is too small or too short will cause downgradient erosion from the increased water velocity during severe storm events. A 'hanging' culvert (bottom of the culvert is above the receiving channel) will create a deeper and wider channel.

1. PIPE INLET PROTECTION

The inlet is the gradual transition from ditch to pipe (small pool, catch basin, etc.) without overtopping or eroding the channel banks. The protection at the pipe inlet prevents scour and deterioration caused by flow velocity, change of direction, turbulence, or suction when water enters the pipe.

ENGINEERING DESIGN

- The inlet to a culvert may be fitted with a **trash guard** to prevent debris from entering and plugging the structure in high littering areas or where the discharge is to a natural resource.
- A **pressure-relief device** should be provided if needed to control uplift pressures.
- **Scour protection** from the entrance velocity, turbulence, or suction should extend to no less than one pipe diameter above the pipe (width on rectangular conduits) on either side of the approach channel.
- The **slope of a vegetated channel** that is on gravel or clay should be flatter than 2:1 and the top of the conduit should extend beyond the fill by at least 1/2 pipe diameter. On sands and silts, the sides of a vegetated channel should be flatter than 2.5:1 and the top of the pipe extending beyond the fill by at least one pipe diameter.
- A rigid reinforced **inlet headwall** (concrete) should withstand settling or frost heaving without cracking or failing. Structural non-rigid headwalls (riprap) should have an inward camber and be protected from piping (geotextile, compaction, anti-seep collar, etc.).
- **Riprap** should withstand the velocity of flow. Riprap should be underlain by a gravel filter or a non-woven geotextile.

CONSTRUCTION SPECIFICATIONS

- The inlet protection should extend at least one pipe diameter above and beyond the conduit.
- Inlet protection with vegetation may be appropriate for small pipes that receive small flows and with an embankment that has a shallow side slope (3:1 or less). Seeding and mulching (hay or stapled erosion control blanket) should be applied within 7 days of final installation. Full stabilization is 90% vegetation.
- Riprap should be installed as soon as possible upon completion of a pipe inlet with a backslope steeper than 3:1. The rocks should be angular and sized to withstand the velocity of flow and should be underlain with a geotextile to prevent piping through the backfill material.
- The inlet protection should camber toward the swale's side banks.
- Any other rigid retaining structures (headwall) should be reinforced to withstand settling, frost heaving, or any other loading without cracking or failing. Use industry standards for concrete structures.

2. PIPE OUTLET PROTECTION

Pipe outlet protection is the armor and/or plunge pool at the outlet of a culvert that prevents scour or turbulence, and will dissipate the flow energy from the pipe to the channel. For channels with a continuous flow, the culvert should be imbedded one quarter (1/4) its diameter to prevent a 'hanging' condition (drop from the pipe outlet to channel).

ENGINEERING DESIGN

- All culverts should be protected from its discharge (flow exit velocity, scour, turbulence, or suction). If the pipe discharges onto a naturally level and vegetated area, an energy dissipator such as a level spreader should be provided. If the outlet discharges into a ditch or swale, a plunge pool or apron is necessary.
- The **capacity of the pipe** during the 24-hour, 10-year storm should be determined using Manning's Equation and the depth of **tailwater** in the channel. If the tailwater depth is less than half the diameter of the outlet pipe, it should be considered as a minimum tailwater condition. If the tailwater depth is greater than half the diameter, another engineering method needs to be utilized. Discharge pipes without a defined receiving channel have a minimum tailwater condition.
- An **apron** should protect and stabilize the culvert outlet the full width of the bottom and one foot above the maximum outflow elevation.
- If the pipe discharges onto a **flat area**, the apron should have a width that is three times the outlet pipe's diameter; and for a minimum tailwater condition, the downstream end of the apron should have a width equal to the pipe diameter plus the length of the apron. The apron should be level along its length (0% grade)
- If the pipe discharges into a **well-defined flat channel**, the riprap apron should extend across the channel bottom, and one foot above the maximum tailwater depth or to the top of the bank. The side slopes of the channel should be no steeper than 2:1.
- If the pipe discharges into a **well-defined sloping channel**, the plunge pool should be sized and protected per the attached table. The riprap on the sides of the pool should taper from the pool to the top of the pipe, to the high water elevation or one foot above the maximum tailwater depth.
- The **median stone size** for riprap should be determined from the following table.
- A **gravel filter and/or filter fabric** should be installed to prevent piping and the loss of fines from beneath the rock.
- A **naturally vegetated earthen pool** may be adequate if the natural soils in the existing receiving channel can withstand the maximum flow velocity based on the soil type and soil velocity as found in Appendix C. The on-site soils must be confirmed at the time of installation.
- The **outlet area** (plunge pool, apron, or other device) should be either over-excavated to receive the riprap protection or reshaped with loam, seed, mulch etc. to blend with surrounding conditions.
- An erosion control blanket is recommended to protect new seeds from washouts. Install per the manufacturer's specifications.

PLUNGE POOL SIZING (minimum)

SIZE	RIPRAP SIZING (D_{50})	WIDTH At the narrow end of pipe	LENGTH For slow flows (no pressure head)	LENGTH For high flows (with pressure head)
12"	5"	3-4'	4-6'	8-10'
18"	8"	4-6'	6-8'	12-18'
24"	10"	6-8'	8-10'	18-22'
30"	12"	8-10'	12-14'	22-28'
36"	14"	10-12'	14-16'	28-32'

The diameter of the largest stone size in the mix should be about 1.5 times the D_{50} and the smallest one about one half the size. The thickness of riprap should never be less than 2 times the rock D_{50} .

CONSTRUCTION SPECIFICATIONS

- If the pipe discharges onto a flat area, the apron should have a width that is three times the outlet pipe's diameter. If the pipe flows have the potential of causing a gully, a level spreader should be provided.
- The channel side slopes should be no steeper than 2:1. Riprap on the sides of the plunge pool should extend to the top of the channel.
- The plunge pool sizing and the median sized riprap can be determined from the following table. The thickness of riprap should not be less than 2 times the rock D_{50} .
- A geotextile or appropriate gravel filter should be used to protect against piping of soil fines from beneath the rock.
- In a channel that can be revegetated, seed and mulch should be applied within 7 days from final construction.

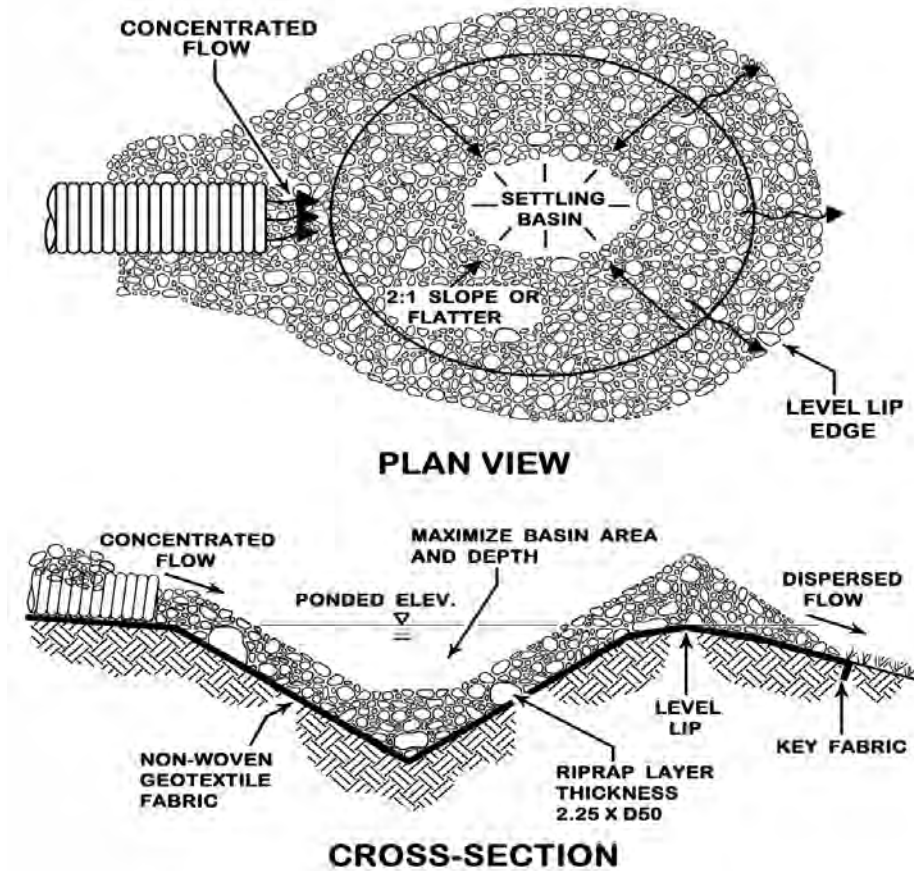

I. ROADS

Any road will alter natural drainage (even a properly constructed one); and the longevity and stability is dependent upon good drainage as any water on the road surface or in the road base will cause pavement collapse, washouts and potholes. Also, without proper drainage a road will require more frequent and costly maintenance. When a **road base or subgrade** is poorly drained, a woven geotextile fabric over the full road width provides strength and stress distribution over the soft soils by dispersing the vehicle weight over a broad area. It will preserve the integrity of the gravel (at least 10-12 inches of good road gravel).



The preferred road construction is above natural ground elevation for positive drainage. Cuts and fills are more of the norm for roads constructed along the contour of sloping sites.



Good road surface and base material contains gravel, sand, and a few fines. Gravel and sand in the subbase provide strength and drainage.



A woven geotextile fabric will strengthen a road constructed over soft or poorly drained soils.



A rock sandwich can provide a permeable road base if built of coarse rocks and wrapped in geotextile fabric to let water drain downgradient.

1. GRAVEL ROADS

For a long-lived gravel road, a well-constructed road foundation base of coarse material for good drainage and support (i.e., sand and gravel with few fines), stable ditches that do not intercept the seasonal groundwater table and a road surface with enough fines to bind the particles (without becoming muddy when wet and cause dust problems when dry) are required.

GRADING restores the road crown and levels out wheel ruts, potholes and wash-boarding (light soil particles blown away by fast moving cars). The crown of gravel roads should be ¼ inch of crown per foot of road width (6" for a 25 foot road). Grading and crowning should occur when the road is moist (to loosen the gravel). Scrape the material that has been pushed to the sides (false berms) into the center and grade the full depth of potholes. Bulldozers are not recommended for grading.

GEOTEXTILE FABRIC will strengthen the road when constructed over soft or poorly drained underlying soils that are prone to tire rutting. A woven geotextile will provide linear strength by distributing the vehicle weight over a broad area. The geotextile should span the road width, extend 10-15 feet beyond the area.

WATERBARS are constructed at a 30-45 degree angle to intercept runoff and for dissipation to the side. Waterbars should be spaced every 250 feet on a 2% road and every 30-40 feet for roads with a 20% grade. In bends or where surface runoff needs shed to one side, the road may be super-elevated. Broad-based dips have a wider base than waterbars and are more appropriate on year-round roads.

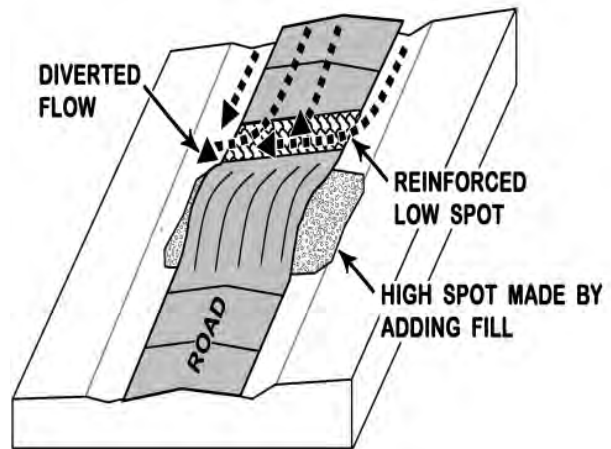

CONSTRUCTION SPECIFICATIONS

- If possible, a road should be constructed with an 8% gradient or less and with cross culverts for water relief. Steeper roads may need riprapped ditches.
- The road base layer should consist of no less than 18-inches of coarse gravel. Soft roads are generally indicative of too many fines in the base material, persistent elevated groundwater table or a base layer that is too thin to support the road.
- The surface layer should be about 4-6 inches thick, well packed, and durable to shed water.
- Loose surface material generally indicates a lack of fines. The surface should have gravel with a maximum particle size of 2 inches (for a smooth ride) and 7-12% fines (to pack well and shed water). Washboarding on a gravel road is the results of too few fines and high speed traffic. Reclaimed (ground up) pavement is more resistant to erosion with the residual asphalt acting as a binder. Ground-up pavement should be compacted with a roller to make a 3-4 inch surface layer.
- Side ditches and waterbars need to be appropriately located and should outlet to a stable area.
- Drainage from the road surface is controlled with crowning, super-elevation and road bends. Use frequent cross-culverts and/or ditches turnouts on long slopes.
- Stabilize all bare soils with seed and mulch or other protection.

2. DITCH TURNOUTS

A ditch turnout will transfer road runoff as sheet flow into a downgradient stable area (a buffer that is stable, level, well vegetated and protected from disturbance). The ditch turnout should blend smoothly with the contour elevation without any sharp drops or irregularities. See the *Level Spreader* information in the “*Swales and Ditches*” Section for additional details.

ENGINEERING DESIGN

- A level lip spreader may be necessary if the drainage area is greater than 2 acres or the discharge has the potential to cause channelization below the turnout.
- Ditch turnouts should be located where no channelization or erosion will occur.
- Roads with a long uphill on a steep areas should have more frequent turnouts should for a smaller drainage area.

CONSTRUCTION SPECIFICATIONS

- Each ditch turnout should discharge the runoff as sheet flow. An easement may be necessary for flows that will cross into an adjoining property.
- Turnouts should be placed as far away from a stream as possible and on the contour.
- The spacing of ditch turnouts is a function of the road grade and volume of runoff. As a guide, one turnout should be provided every 200 feet for a road with a 2% grade and 30-40 feet for roads steeper than 10%.
- Ditch turnouts should be constructed in undisturbed soil. If fill is used, compaction of the fill should meet 95% of Standard Proctor density.
- The dimensions (length and depth) of each ditch turnout depend upon the expected amount of runoff to allow pooling of the runoff before its discharge. The lip should be constructed along the contour and the side slopes should be less than 2:1 and stabilized.
- Once constructed, the turnout and level lip spreader may need to be stabilized with vegetation (seed and mulch – preferably erosion control blanket in the flow areas) or 4-6 inches of clean stone (not always necessary for level areas that are forested).
- Remove sediment from the ditch turnout when the swale is halfway full of sediment and debris or the structure is no longer functioning properly.
- Regularly inspect the ditch turnout for channelization or erosion and repair as soon as possible.



The receiving area should be stable and well vegetated or preferably a wooded buffer.



The entry angle from the channel to the level spreader should be no greater than 30 degrees to prevent scour and short circuiting.



The spreader should be level and prevent channelization. In a temporary situation, erosion control mix or a berm of brush may provide the velocity reduction necessary to promote dispersion. Stone berms are recommended for larger flows.

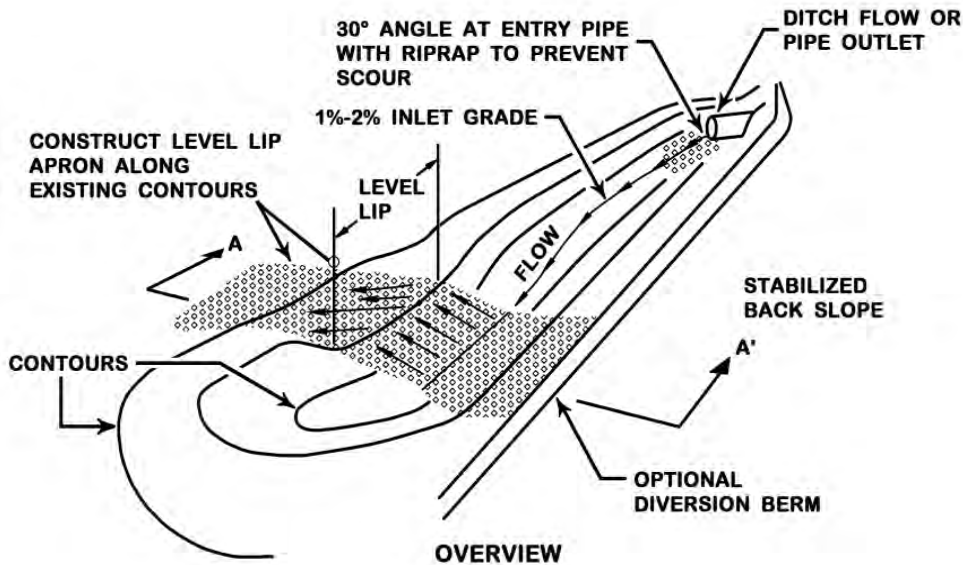
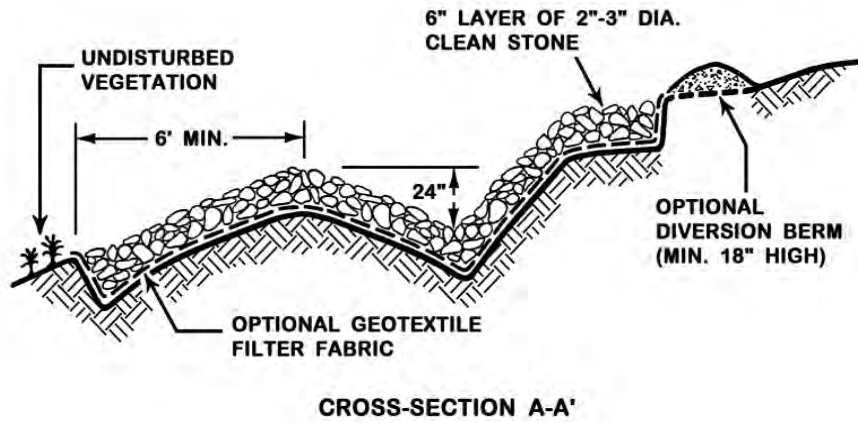

3. FRENCH DRAINS AND ROCK SANDWICHES

French drains and rock sandwiches are very effective for the crossing of wetlands or in road cuts where the groundwater table is intercepted. They reconnect the natural hydrology, strengthen a road on soft soils, and prevent groundwater from wicking into the road fill material. They can be used in conjunction with a culvert if a large volume of runoff needs to be discharged during high rain events or for periods of high groundwater.

FRENCH DRAINS work like a rock sandwich as they are a narrow drainage trench placed parallel to the toe of road cuts with drainage material wrapped in fabric and surrounding a perforated pipe. The drain should be 6 inches in diameter or larger and should daylight to a stable downgradient discharge point.

ROCK SANDWICHES, unlike culverts, do not concentrate water to a single entry and exit point but can spread the water over a distance, such as the width of a wetland.

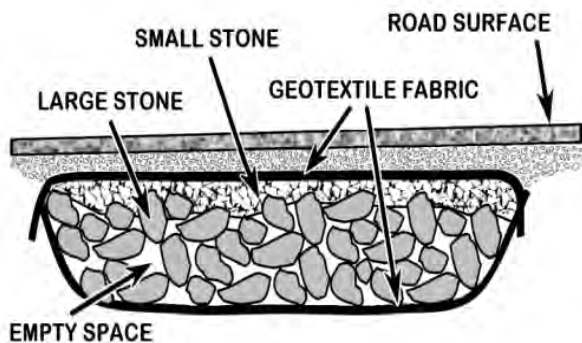

CONSTRUCTION SPECIFICATIONS

- In a new wetland location, do not stump and grub the surface under the road footprint. Cut trees close the ground, leaving the stumps and brush to provide structural support to the new road as it will not decompose under water. In a cut and fill location, minimize the area of ground disturbance and avoid excavating ditches.
- Place a woven geotextile fabric over the width of roadway with overlapping joints of at least 24”.
- The core material of the rock sandwich should be a layer that is 12” or more of clean 3-6” diameter stones placed on the full width of the roadway.
- Cover the rock layer with another filter fabric leaving the upgradient and downgradient ends of the rock layer exposed to allow the free movement of water.
- Place 6 inches or more of sub-base road fill, compact, and cover with surface material. When more than 2-3 feet of fill is needed to bring the road to finished grade, a third layer of filter fabric should be added for structural strength and to prevent the fines in the road subbase from moving to the drainage layer.
- Prevent plugging of the drainage layer by placing a layer of 3”-6” stone on the cut face up to the height of seeps to stabilize any seepage area.
- If the rock sandwich is in a crossing that has a defined drainage way that experience occasional large flows, a culvert should be installed slightly above the bottom of the rock sandwich for relief.
- Regularly check the upslope of the rock sandwich and clear any eroded soil, road sand, debris or leaf litter to prevent the clogging of the structure.
- Line a French drain with a non-woven geotextile to prevent clogging and to extend the life of the pipe and gravel. Lay the geotextile in the trench and fill. The ends can be folded over the top and then covered with soil. The drain should have a continual downhill discharge to a stable area.

J. STREAM CROSSINGS

A stream crossing is a structure placed in a waterway to provide safe, sediment-free access. Stream crossings should be designed and installed to prevent damage to the waterway and to avoid blocking fish passage. Understanding the stream's volume under all flow conditions, the flow velocities, and the soil in the area within or adjacent to a stream channel are necessary to minimize the risk of discharging sediments to the stream.

Any structure or work within the waterway of a stream is subject to the rules and regulations of the U.S. Army Corps of Engineers for in-stream modifications (404 permits), the Maine DEP under the Natural Resources Protection Act, and the Land Use Planning Commission (LUPC) for work in the unorganized territories. The Maine Department of Inland Fisheries and Wildlife should be consulted for fish and wildlife passage issues. Other information and guidance may be available from the Maine Forest Service.

COMPANIONS: *Vegetation, Riprap, Slopes, Roads, Cross Culverts*

IMPORTANT NOTE

Construction of "Stream-Smart" road crossings is recommended and begins with proper planning:

- Select the right place to cross a stream.
- Determine the construction schedule, public use, traffic, loads, and patterns of crossing.
- Determine all necessary stream water controls such as by-pass, pumping, cofferdams, etc.
- Determine all stabilization measures and how the stream will be restored to its natural conditions.
- Identify an appropriate staging area for pipe assembly, equipment and materials storage area, and for the disposal of construction debris.



After installation, the streambed should be restored to its original shape and slope.

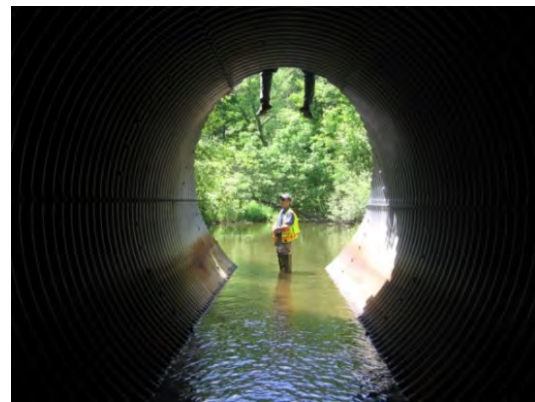

Inspect the structure after major rain events and repair immediately. Remove any debris that may block or constrict the culvert opening.

1. CULVERT CROSSINGS

A crossing should maintain a natural stream condition by avoiding “pinching” or “constricting” the channel. If possible, it should exceed the stream channel width to prevent erosive forces in the channel, allow room for wildlife passage and high stream flows.

IMPORTANT NOTE

Follow the following ‘Stream-Smart’ principles, or hire an engineer when sizing a new or replacement culvert:

- Span the stream with the correct culvert size. The crossing should be at least as wide as the bankfull width.
- The culvert has to be set at the right elevation.
- Slope the culvert to match the stream.
- Add substrate within the crossing to provide riffles and pools for fish passage.

CONSTRUCTION SPECIFICATIONS

- Delay the construction if any major rain event is predicted. Check the weather daily.
- Locate the crossing where the crossing will minimize soil disturbance and will receive the least amount of road runoff. Look for soils and embankments that will support equipment or that can be reinforced.
- Construction equipment should be kept out of streams.
- The angle of the crossing should be within 15% from the alignment of the stream. This will require a longer culvert (i.e., skew the culvert with the angle of the stream, not the angle of the road).
- Roadside ditches should terminate to a level spreader and buffer and not at the stream.
- Culverts should be placed on compacted soil and stabilized with stone or gravel.
- Connect two lengths of culvert from downstream to upstream and protect the ends from crushing. The joints should be clean and free of soil or debris.
- Backfill should be installed in 6-inch lifts with compaction beneath and around the pipe to minimize frost heaves and washouts. Native material may be used if granular. Lift compaction should continue up to the subbase.
- Multiple culverts should be separated by at least 12 inches of compacted fill.
- Any riprap needs be underlain by filter fabric. The rocks should be angular and durable.
- Rock sandwiches can be used in conjunction with a culvert to handle flood flows and maintain the floodplain characteristics.

**BOX CUT INSTALLATION
NON-FROST SUSCEPTIBLE SOILS**

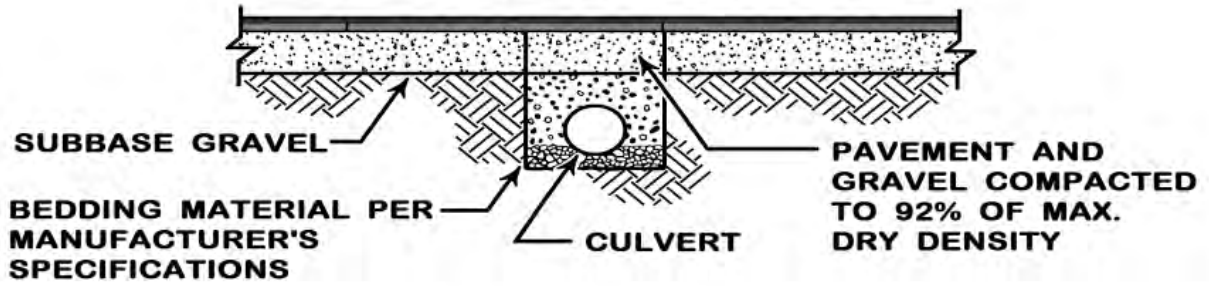

**TAPERED TRENCH INSTALLATION
FROST SUSCEPTIBLE SOILS**

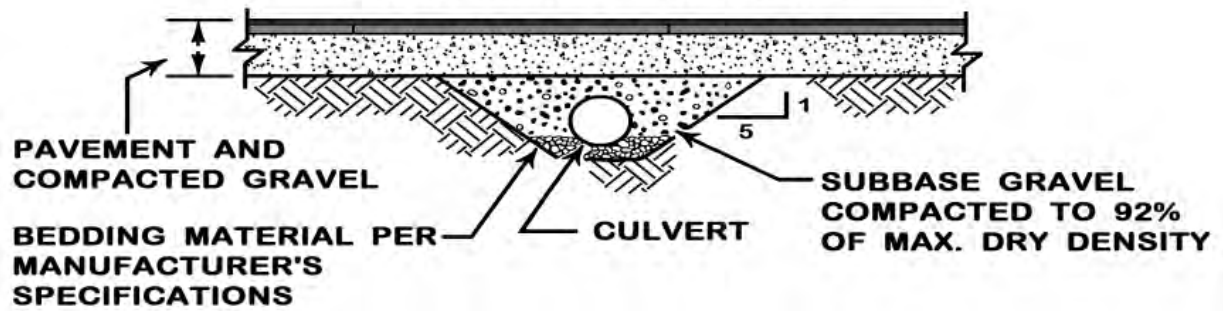

CULVERT SIZING BY THE 3X RULE

Average Channel Width: Measure the stream (2-3 locations) at bankfull width (water stains on rocks, change in vegetation, or a debris line along the bank) and average (add the measurements and divide by their number).

Average Stream Depth: Measure the depth (2-3 locations) from the bottom to bankfull elevation and average (add the measurements and divide by their number).

Use the table to find the culvert size for the width and depth (upsized for in-between measurements).

	AVERAGE STREAM WIDTH (FEET)	AVERAGE STREAM DEPTH (INCHES)												
		6	8	10	12	14	16	18	20	22	24	26	28	30
CULVERT DIAMETER (INCHES) (UPSIZE FOR IN-BETWEEN MEASUREMENTS)	1.0	18	21	21	24	30	30	30	30	36	36	36	36	42
	1.5	21	24	30	30	36	36	36	42	42	42	42	48	48
	2.0	24	30	30	36	36	42	42	48	48	48	54	54	54
	2.5	30	30	36	42	42	48	48	48	54	54	60	60	60
	3.0	30	36	42	42	48	48	54	54	60	60	60	66	66
	3.5	36	36	42	48	48	54	54	60	60	66	66	72	72
	4.0	36	42	48	48	54	54	60	66	66	66	72	72	78
	4.5	36	42	48	54	54	60	66	66	72	72	78	78	84
	5.0	42	48	48	54	60	66	66	72	72	78	78	84	84
	5.5	42	48	54	60	60	66	72	72	78	78	84	84	90
	6.0	42	48	54	60	66	66	72	78	78	84	90	90	96
	6.5	42	54	60	60	66	72	78	78	84	90	90	96	96
	7.0	48	54	60	66	72	72	78	84	84	90	96	96	102
	7.5	48	54	60	66	72	78	84	84	90	96	96	102	102
	8.0	48	54	66	66	72	78	84	90	90	96	102	102	108
	8.5	48	60	66	72	78	84	84	90	96	102	102	108	108
	9.0	55	60	66	72	78	84	90	96	96	102	108	108	114
	9.5	54	60	66	72	78	84	90	96	102	102	108	114	114
	10.0	54	66	72	72	84	90	96	96	102	108	114	114	120
	10.5	54	66	72	78	84	90	96	102	108	108	114	120	120
11.0	60	66	72	78	84	90	96	102	108	114	114	120	126	
11.5	60	66	78	84	90	96	102	108	108	114	120	126	126	
12.0	60	66	78	84	90	96	102	108	114	120	120	126	132	
12.5	60	72	78	84	90	96	102	108	114	120	126	132	132	
13.0	60	72	78	90	96	102	108	114	114	120	126	132	138	
13.5	66	72	84	90	96	102	108	114	120	126	132	132	138	
14.0	66	72	84	90	96	102	108	114	120	126	132	138	144	
14.5	66	78	84	90	96	108	114	120	126	126	132	138	144	
15.0	66	78	84	96	102	108	114	120	126	132	138	144	144	

2. TEMPORARY STREAM DIVERSION

A temporary stream diversion for a short duration construction project provides a dry working environment while maintaining the stream flow. A more permanent and engineered structure will be needed for crossings over large streams, or for a long construction period (greater than 3 months). Weather reports need to be monitored daily to prepare the project for anticipated storm events. Work with an engineer for design and construction guidance.

ENGINEERING DESIGN

- Rules and regulations of the U.S. Army Corps of Engineers (404 permits), the Maine DEP, and the Land Use Planning Commission (LUPC) apply to any work within a stream. Also, consult with the Maine Department of Inland Fisheries and Wildlife for fish spawning or migration dates.
- The location of the stream diversion should cause the least disturbance to soils and stream bank vegetation.
- The water level between the upstream and downstream should not exceed 1% and should have a velocity similar to normal flow conditions. The base flow of the stream should be maintained.
- Washed coarse aggregate (3/4 inch to 4 inches or larger) should be the only aggregate used for a stream diversion.
- The height of a channel diversion structure should be at half the height of the bankfull width (streambed to top of stream bank) plus one foot.
- The dewatering water from the construction area should be pumped to a settling basin.
- Stockpiles of materials should be located outside the 100-year floodplain.
- The channel connections (downstream and upstream) should be constructed under dry conditions. The process of excavation and stabilization should be uninterrupted.
- All construction materials should be on-site prior to any stream disturbance.
- A sandbag-conduit diversion should only be used for very short time duration. The sandbags should be resistant to ultra-violet radiation, tearing and puncture, and woven tightly enough to contain the fill material (sand or fine gravel, no fines).
- A pipe conduit should have the hydraulic capacity for a flow rate of 30 cfs (cubic feet per second) per square mile of drainage area.
- A plastic or geotextile fabric lined channel should be limited to small streams (< 1 square mile watershed), and should be sized to convey the 24-hour, 2-year storm event.
- The fabric should be placed so that it sits tightly with the channel and should be continuous if possible (overlaps from upstream should cover the downstream portion by 2 feet or more).
- The fabric should be keyed into a 2 x 2-foot trench upstream and at 50 foot intervals (or at the nearest overlap). The keyed-in trench should cross the whole channel (bank to bank).
- The fabric should be anchored with 18-inch pins and washers (1-inch diameter) or per the manufacturer for the anticipated stream flow velocity and type of geotextile fabric.
- The entire bottom of the channel should be riprapped for high flows. The fabric does not require pinning if the channel is riprapped (without dropping the rocks).
- An impervious plastic liner can be used in lieu of geotextile fabric if 6 mil or thicker and is resistant to ultraviolet light for a period of 60 days or more.

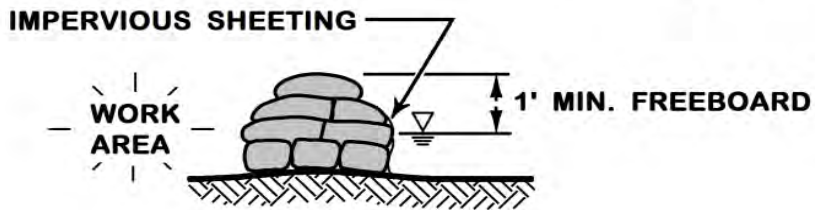
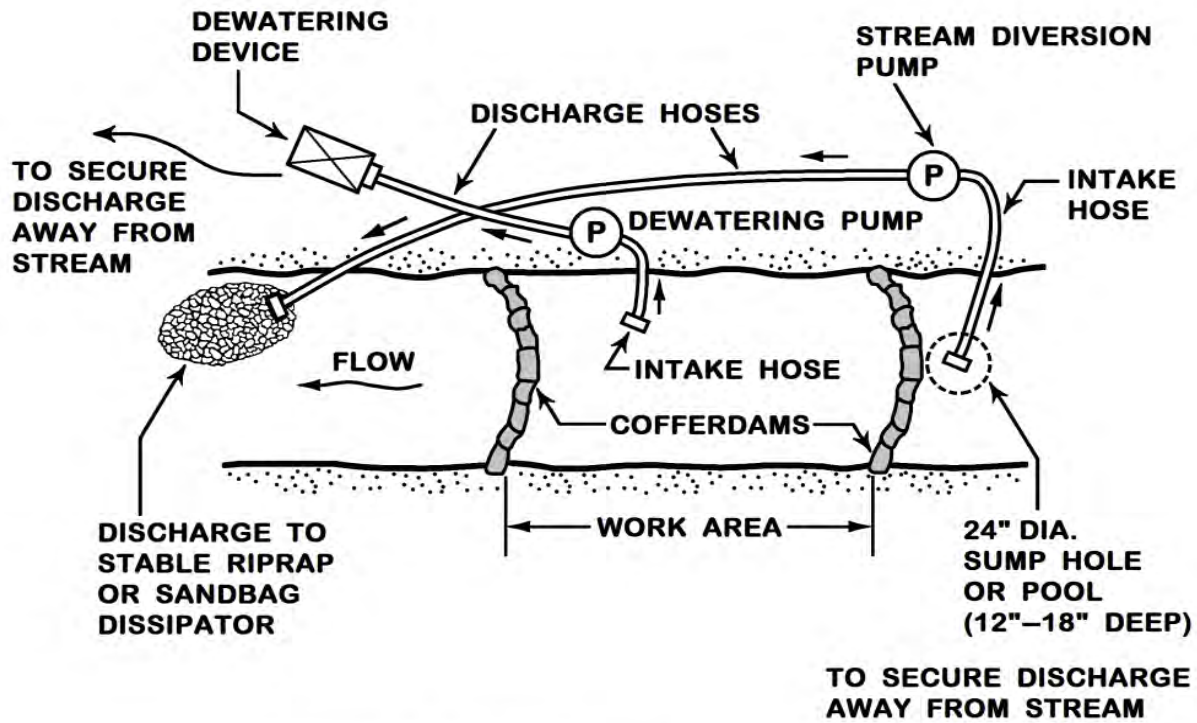

SANDBAG CROSS-SECTION

CONSTRUCTION SPECIFICATIONS

- The construction of a channel diversion should begin from downstream and work upstream.
- The diversion structure should be sized to contain all stream flows. A large project would benefit from a cofferdam as well as a diversion.
- The conduit and pump should have the hydraulic capacity to handle all anticipated flows. The diversion should be constructed under dry conditions and be fully stabilized (sandbags or riprap) before use.
- Water from within the excavation/construction area should be pumped to a dewatering basin before reaching the stream.
- A block net should be provided upstream of the intake to reduce entrainment of fish and amphibians to a pump.
- A temporary by-pass pipe or culvert that is protected from crushing may be placed across the road.
- Clean water should re-enter the stream without scouring. A created apron of geotextile fabric and riprap or equivalent should be provided unless the discharge location is stable (rocky stream bed).
- The discharge hose(s) should be securely anchored.
- A stream diversion should be regularly inspected to ensure that the structure is not obstructed, that sediment is not discharging to the stream, and fish passage is not blocked. All damages should be repaired.
- If a major storm is predicted, emergency measures may be needed to prevent damage.
- At the end of construction, all temporary stream diversions should be removed and all areas stabilized and restored.

3. IN-WATER WORK

A large construction project within or adjacent to a waterbody may require a cofferdam and dewatering of the working area in addition to a stream diversion. Working with an engineer is recommended. These structures should be in use for the shortest period of time and should never constrict the channel or cause flow backups during high flows as they may contribute to flooding of the upgradient area or cause damages downstream.



COFFERDAMS are usually installed a short distance (10'-15') upstream and downstream of the construction area. On small streams, several layers of sand bags may be sufficient; but in larger streams, several options can be implemented such as: commercial size sandbags (cubic yard size), sheet piling, cement waste blocks, etc. The downstream cofferdam prevents back-flushing into the construction site.



The cofferdam should be inspected and repaired immediately. It should be left in place for at least 24 hours after the completion of disturbance activities to allow for the settling of sediments.

CONSTRUCTION SPECIFICATIONS

- Install a cofferdam in accordance with the manufacturer's recommendations.
- The staging area should be cleared of sharp objects, debris, brush or tree roots, or anything else that may snag the structure.
- Cofferdams are rarely completely watertight and will require continued dewatering. Muddy water that accumulates within the dammed area should be removed with a "mudsucker" pump designed to handle dirty water. The discharge should be directed away from the stream and filtered to remove suspended sediments. Do not allow the outflow to channelize and cause erosion.
- An impermeable plastic sheeting barrier should be installed on the upstream side of the structure to reduce leakage.
- Ensure that no problem (flow obstruction, sediment discharge, blockage to fish passage, etc.) develops due to pumping or discharging. Repairs should be made immediately.

4. TEMPORARY STREAM CROSSINGS

A temporary crossing can be a bridge, a ford, or a culvert that will be used for less than one year. It should not constrict the channel and should not cause flow backups or washouts during periods of high flows. *Consult with the DEP on whether a NRPA permit is required.*

Temporary culverts can cause equal amount of disturbance as a permanent culvert and should be constructed with the same care. The culvert should be sized to provide for the passage of high stream flows.

CONSTRUCTION SPECIFICATIONS

- A temporary stream crossing that will have to overwinter should be sized for high flows.
- Temporary crossings should be minimized (one lane of traffic).
- Locate the crossing for the least stream bed disturbance and for bank stability (the narrower the stream and the stronger the banks are best). Site the structure where the stream banks have the strength to support vehicle access or reinforcement should be provided.
- The entire ford approach area should be protected with 4 -12 inches of coarse aggregate. Geotextile fabric (woven or nonwoven plastic) may be used to distribute the load, retain fines or reduce mixing of the aggregate with the stream bottom.
- Washed coarse aggregate (3/4" to 4") is the preferred aggregate for fords. Sands, silts, or clays should not be used within the waterway.
- The crossing should not cause a hydraulic jump in the stream.
- A waterbar should divert road runoff to a level spreader and buffer within 50 feet from the crossing.
- Periodically inspect the crossing to ensure that debris or sediment are not discharging to the stream or blocking fish passage.
- The removal of excess materials from the waterway and re-stabilization of side banks is usually needed at the completion of the project. The road approaches through the banks should be permanently stabilized but not backfilled.

ENGINEERING DESIGN - Temporary Culvert

- The invert elevation of a culvert should be at or below the streambed for fish passage.
- The culvert cross sectional area should be the largest pipe diameter equal to the undisturbed cross sectional area of the stream at bankfull width, and should fit into the existing channel without major excavation or approach fill. Multiple pipes with a cumulative area exceeding that of the channel area (multiple culverts must be separated by 12 inches or more of compacted fill) may be used when placed at different elevations. A culvert should have a minimum diameter of 18 inches.
- In watersheds larger than 1 square mile (640 acres), the culvert should be sized for the 100-year storm to comply with federal regulations.
- A geotextile fabric that separates the streambed and backfill will reduce settlement, improves stability and facilitate the removal of the crossing and fill. The fabric should cover the streambed and extend 12-18 inches beyond the end of the culvert and bedding.



TEMPORARY BRIDGES can be made of wood, metal, or other materials. The crossing should span the channel entirely and should butt tightly to both banks to prevent erosion. Run planks should be fastened for the length of the span to distribute wheel loads; and curbs or fenders should be provided for additional safety. The bridge should be secured to prevent bridge floatation during high water flows.



TEMPORARY FORDS consist of the reinforcement of the streambed for traffic while maintaining adequate fish passage but should not be used for streams with soft mucky bottom or streams with a large flood plain. A minimum of 6 inches of flow depth over the ford is required for fish passage and should be provided on one side of the ford only. A temporary water ford may be made of timber mats or blasting mats.

ENGINEERING DESIGN - Temporary Bridges

- **Bridges** should fully span a stream to least disturb its morphology and fish habitat, and should be placed at or above flood stage elevation to prevent the entrapment of floating materials and debris.
- The **abutments** should be parallel to or at the top of the stream banks; but no footing, pier or bridge support can be placed within the channel without regulatory approval. The abutments need to be placed outside the bankfull width and set in stable conditions. This may require long bridge supports or construction mats for the bridge platform.
- A bridge **platform soil entrapment** should be constructed so that soil tracked onto the bridge cannot fall into the stream either between platform sections or off the sides (e.g. filter fabric laid between layers of mats and screwed with 2x10 sideboards along the bridge exterior to entrap soil that drop off equipment.
- **Waterbars and ditch turnouts** may be required at the approaches to the crossing to direct stormwater away from the stream as they are typically located in a valley or in a downslope position from the construction project.
- **A bridge** may consist of logs, sawn timber, pre-stressed concrete beams, metal beams, or other materials that will support the anticipated load, and that can be easily removed and reused.
- All **decking members** should be placed perpendicular to stringers spanning the bridge, butted tightly, and fastened. Optional run planking can be fastened for the length of the span to distribute vehicular load. Curbs or fenders should be installed for safety along the outer sides of the deck.
- **Bridge anchors** should secure the bridge at one end with a steel cable or chain to prevent channel obstruction in the event that floodwaters float the bridge. Acceptable anchors are large trees, large boulders, or driven steel anchors. Anchoring should prevent the bridge from obstructing the flow.

ENGINEERING DESIGN - Temporary Access Ford

- **Temporary fords** may be used where the streambed is armored with naturally occurring bedrock or can be protected with an aggregate layer.
- The **approach road** should be no steeper than 20% (5:1) and should be covered with geotextile fabric and 4 inches or more of coarse and clean aggregate. Any material from the banks should be stored outside of the flood plain.
- A **geotextile fabric** should separate the streambed and backfill to reduce settlement, improve crossing stability, and to facilitate the removal of the crossing. The fabric should cover the streambed and extend 12-18 inches beyond the crossing.
- The **bedding material** should be less than 12 inches or 1/2 the height of the existing banks.
- **Unobstructed stream flow** is necessary for fish passage and to maintain natural stream water level. It can be achieved with one side of the ford deeper than the other.

K. SITE SPECIFIC BMPs

Specific stabilization or treatment measures may be necessary for unique project developments or restorations where the site's particular conditions such as soil type, vegetation, past or intended use, slope, depth to groundwater or moisture content, weather exposure, etc. will warrant individualized attention. Some of the most common situations and their erosion control and stabilization measures are described in this section.

1. SLOPE AND SHORELINE STABILIZATION

Coastal shorelines and stream banks should be stabilized and reinforced before surface erosion and deep rooted collapse cause land loss within the resource. A slope may be at-risk of failing for the following conditions: wave actions or high flows during major storm events, groundwater flows and seeps, foundation drains, trees that are too big for the slope, high bedrock, lack of friction between soil layers, etc. The longer one waits to make repairs to a failed slope, the more intrusive the reconstruction, and the higher the costs. *See the Slopes section for additional information.*

Any structure or work within a waterbody is subject to the rules and regulations of the U.S. Army Corps of Engineers, the Maine DEP under the Natural Resources Protection Act, and the Land Use Planning Commission (LUPC) in unorganized territories.

COMPANION BMPs: Sediment Controls, Mulching, Vegetation, Slopes, Swales and Ditches.



COASTAL SHORELINE

In a coastal environment, the armorment base should be buried at least 3 feet within the beach bottom for toe protection. The rocks in the armorment base should be angular, 3-4 feet in diameter, and should be stacked at an angle that is no less than 1.3:1. If the embankment is based on bedrock, the base layer should be pinned with ¾ inch or larger galvanized rebars. If the depth of surface water (at the mean high tide) increases to more than 10 feet within less than 30 feet from shore, the height of armorment should be established based on the wave fetch, velocity and wind direction (per US Army Corps of Engineers standards).



VEGETATION

Above the armorment base, slope stabilization can consist of riprap and/or vegetation. Vegetation can thrive on slopes that are less than 2:1, and should be used unless a building is within 50 feet from the crest of the embankment, or for the protection of large trees. For slopes that are less than 10 feet high, riprap can be placed on a slope that is less than 1:1 to a point 4 feet above the maximum spring high tide where the slope should break to a 3:1 slope for the establishment of vegetation.



GROUNDWATER DRAINAGE

If the embankment is at risk from groundwater seepage, groundwater interception should be provided with a French drain (gravel trench) placed 3 feet or more from the top of the embankment to lower the water table. The depth of the collection pipe within the trench should be as deep as possible. Other deep seated drainage structures such as wick drains can be considered. The soil profile and groundwater depth should be obtained with multiple hand auger boreholes.

CONSTRUCTION SPECIFICATIONS

- The bank slope should be cleared and graded to provide a uniform surface free of projecting stumps, rocks, logs, etc. Stable trees and shrubs should be preserved, protected and incorporated into the stabilization project. Roof runoff and foundation drains need to be discharged to a stable area over the bank.
- If the embankment is at risk from upgradient surface water runoff or a high volume of groundwater seepage, provide a French drain (stabilized drainage swale or a gravel interception trench) located 3 feet or more from the top of the embankment with a discharge point that is away or below the revetment.
- If the soils within the embankment are silt or clay, a layer of clean gravel, 4 or more inches thick, should be placed beneath the geotextile filter fabric for the dissipation of pore pressure and drainage. Clayey soils have a natural angle of repose that is nearly vertical while embankments with sandy soils may have an angle of repose that is shallower than 1:1.
- Anchor and staple the geotextile fabric on the upper edge of the bank with the fabric buried 12 inches into the native soil. Fabric sections should overlap 12 inches and be stapled along the overlap (no more than every 3 feet). The fabric should be a non-woven geotextile with a fabric weight of 8 ounces per square yard or greater if no calculation is performed.
- Provide a 4 inch layer of crushed rock or coarse well-graded gravel fill over the geotextile fabric for protection from the larger rocks.
- Stone should be placed by hand or excavator bucket (not dumped) to avoid tearing or puncturing the fabric. Larger stones may be selectively placed at the base of the bank for added stability. The placement of stones should produce a well-graded, interlocking mass of stones with minimum voids.
- At a minimum, the thickness of the riprap should be twice the diameter of the D_{50} or average rock size.
- The riprap revetment should be installed no less than 3 feet below the lowest anticipated depth of scour or to a depth 2.25 times the riprap stone D_{50} and should extend up the bank to a height equal to the bank-full elevation or to a point where vegetation can be established. The stone size for the revetment should be designed to be stable under all flow conditions.
- Vegetation should be established above the riprap revetment with a six-inch layer of high quality loam, and should consist of light weight woody vegetation and shrubs. Plantings grasses (native to Maine) should be spaced no less than 3 feet on center, and be mulched with heavy woody mulch (such as erosion control mix) or grass. Grass seeds should be protected with an erosion control fabric or mulch.



MODELING AN UNSTABLE SLOPE OR A DEEP SEATED ROTATIONAL FAILURE

If the slope that has the potential for a deep seated rotational failure, model the slope (with applicable computer software) for the site conditions (soil profile, soil type, soil cohesion, groundwater, surface water, surface load, etc.). A safety factor of 1.2 should be considered the minimum. The safety factor may be improved with drainage trenches, dead man anchoring or other engineered structures if the revetment is steeper than 2:1.



RIPRAP REVETMENT OF RIVER AND STREAM BANKS

Riprap revetment on a river bank should start from an end at a stable point on the bank that is cut back to establish a solid and uniform surface. However, the revetment should not disturb the stream bottom to protect fish habitat, to prevent any grade variation and to maintain the cross-sectional area of the river or stream channel. Do not realign the stream channel and do not remove any soil/sand/gravel/cobble bars upstream or downstream of the revetment location.

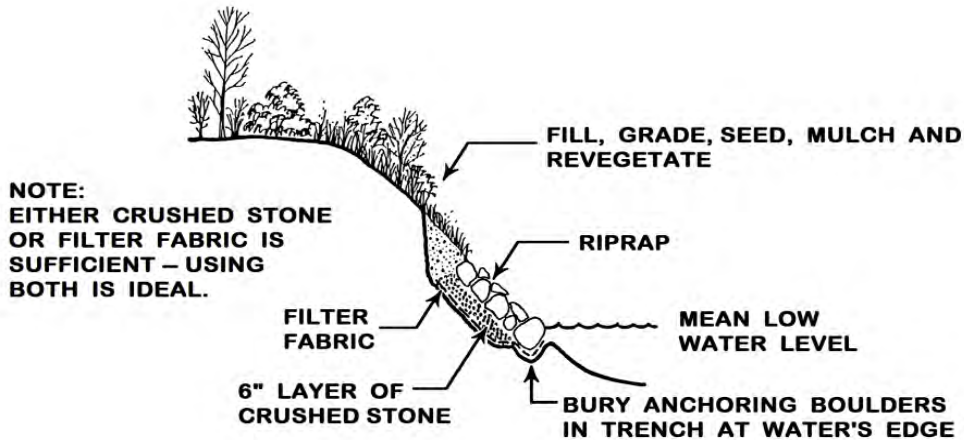

HOW TO RESTORE A LOW ERODED BANK WITH RIPRAP

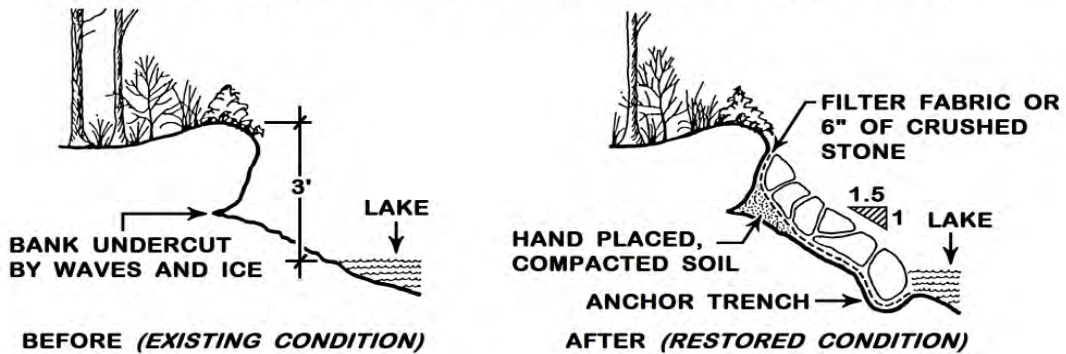

HOW TO RESTORE A HIGH ERODED BANK WITH RIPRAP

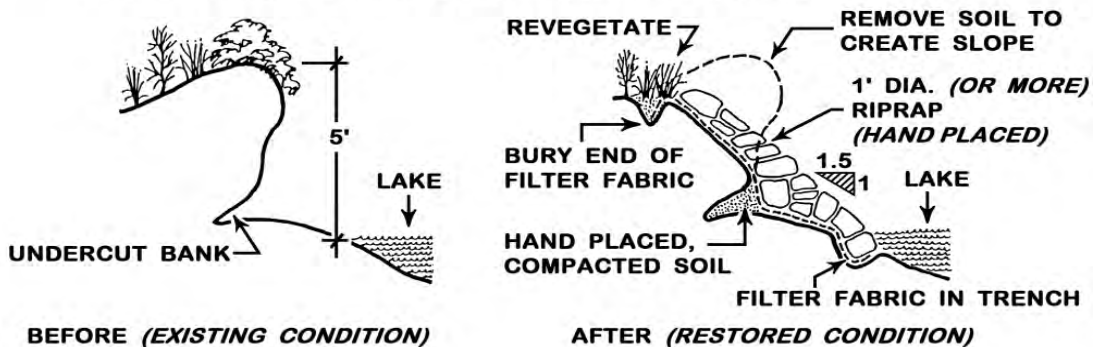

2. BUFFERS

The vegetation, organic duff layer and soil within buffers will filtrate, infiltrate, absorb, decompose, and volatilize sediments and pollutants from a stormwater runoff if the discharge is an overland (sheet) flow. However, the effectiveness of buffers depends on the type, height and density of the vegetation, season of the year, the topography and size of the buffer and exposed area, and the amount of runoff. Based on these variables, a buffer may require a length of flow path that is only a few feet in well drained flat areas to as much as several hundred feet in steeper areas with more impermeable soils.

It is preferable to protect or re-establish a native forest cover than replanting a disturbed buffer. The vegetation should be well developed (preferably composed of woody shrubs and trees of a range of size, age, and species), and with an intact forest floor. Undisturbed natural coarse woody debris adds surface roughness, increases water residence time and infiltration.

COMPANIONS: *Slopes, Mulching, Vegetation, Swales and Ditches.*



FOREST CONSERVATION

Desirable stands of trees will need protection to ensure their survival. Trees to be conserved and preserved should be identified before clearing and construction and located on all plans.



ESTABLISHED BUFFERS

Ideally, vegetation should be well developed, preferably composed of a suitable density of woody shrubs and tree stems of a range of sizes, age classes and species, and an intact forest floor. Concentrated flows should be directed to a level spreader for an even distribution.



BUFFER/TREES PROTECTION DURING CONSTRUCTION

Tree protection barriers and signage should be placed before any earthwork activity, be in good repair, and be the last items removed during cleanup.



LONG-TERM BUFFER CONSERVATION

Once identified, established or constructed, a buffer should be protected from damage, especially if near or within a residential area, in a conservation area, or protected by a deed restriction.

CONSTRUCTION SPECIFICATIONS – BUFFER PROTECTION

- Clearing should be limited to outside of the drip line of trees or at a minimum of 15 feet from the tree trunks; but never closer than 5 feet from a trunk. The tree line should be marked or flagged at a height that is visible to equipment operators.
- Heavy equipment, stockpiles of any materials should never be permitted within the drip line of a tree; and no toxic material should be stored within 100 feet of the drip line.
- When the ground level must be raised around existing trees, a well should be created slightly beyond the drip line of the tree(s) to retain the natural soil elevation in the area of the feeder roots. If necessary, drainage from within the well should be provided.
- Trees should be protected from an embankment cut or trenching activities. The excavation should be located outside the drip line of the trees and no closer than 5 feet from a trunk.
- All exposed or damaged roots should be cleanly trimmed, painted with tree wound dressing and covered with moist soil or other suitable material to keep them from drying out. Any damage to the crown, trunk or branch limbs should be repaired by cleanly cutting off the damaged roots or branches.
- If the soil has become compacted over the root zone, the ground should be aerated (punching holes in the soil with suitable aerating equipment).
- Any disturbed soil must be mulched or planted with permanent vegetation to prevent erosion.
- Inspect buffers and level spreaders for signs of erosion and channelization, and repair immediately. Other indicators of stress include lightning scars, insect or disease damage, rot or damage, overhanging limbs, crown vigor, etc. *Contact the Maine Forest Service for additional assistance.*

ENGINEERING SPECIFICATIONS – EXISTING BUFFERS

- DEP regulations require that existing vegetation adjacent to a natural resource be protected. Some buffers will be permanently protected if intended for phosphorus or stormwater management. Refer to any DEP conservation easement or deed restriction as recorded under a Stormwater Management permit for the property. For more information, contact the DEP Bureau of Land Resources.
- The Maine Department of Inland Fisheries and Wildlife recommends a minimum width of 100 feet of undisturbed vegetation and an additional 150 feet of minimum disturbance on either side of a stream or wetland. The recommended width will vary with the value of the resource. Consult IF&W to determine the appropriate width and location of buffers prior to construction.
- A level spreader may be necessary to promote sheet flow within the buffer and to prevent channelization.
- Diversity within a stand of trees should be maintained unless the elimination of some early successional species such as gray birch, poplar, etc. is warranted; and the removal of dead trees is recommended for the remaining trees to have room to develop. Preference should be given to long-lived native tree species (white pine, red or white oak, beech, sugar maple, etc.), and older trees that will allow the natural regeneration of younger individuals.



NEW BUFFER CONSTRUCTION

A disturbed area that will become a buffer should be seeded with a permanent cover of grasses and legumes. With time, the area will naturally re-establish with denser vegetation (do not allow mowing of the area).



TEMPORARY GRASS FILTER STRIPS

A grassed filter strip may be provided as a sediment trap below an area under construction if built and stabilized early in the construction sequence.

CONSTRUCTION SPECIFICATIONS – NEW BUFFERS

- A buffer should be as long (or deep) as necessary to be effective for the slope and soil type. The stormwater discharge should be located along the contours and spread as sheet flow; and the buffer needs to be level (no natural channelization).
- Construction equipment should be restricted from a buffer area to prevent soil compaction.
- Spring is the preferred planting season for deciduous trees (hardwoods) and early fall (August-September) for evergreens. Trees to be planted as bare-rooted seedlings should be handled only while dormant (in the spring, or after leaf fall in autumn).
- The planting holes for trees should be deep, with perpendicular sides and a loose bottom. The tree/shrub root ball should be spread out, and covered with compacted layers of compost and native soil until the hole is nearly full and soil just over the root ball. Finally, the hole is filled with loose soil, leaving a shallow basin for water retention. Stakes and guy wires will support and prevent swaying.
- Any new plantings should be mulched to prevent temperature or moisture changes, and the soil from washing away (bark mulch or erosion control mix is preferred).
- Transplanted trees should receive an inch of water each week for the first two summers after planting and should be fertilized and mulched yearly after the second year when feeder roots are established.

ENGINEERING SPECIFICATIONS – NEW BUFFERS

- The selection of trees should be based on the availability of sun or shade, local climate, land use and soil conditions (drainage, moisture, acidity; wind; temperature extremes; location of utilities, etc.). The plant's mature height, moisture requirements, root system (proximity to underground pipes), hardiness and maintenance requirement (i.e. dropping of seedpods, flowers, or twigs) must also be considered.
- Native species of plants should be selected as they are best adapted to Maine climate and are easy to grow. *Further assistance on plant selection, planting, health and care is available from the Maine Forest Service, the Natural Resources Conservation Service (NRCS) and the University of Maine Cooperative Extension Service.*

3. STREAM BIOENGINEERING

In streams, healthy vegetation contributes leaf litter, shading and large woody material for many fish and insect species to thrive, full-grown trees hold the soil with their roots and reduce water velocities; and shrubs prevent the formation of eddies during flood flows and protect the trees from ice damage. A fluvial geomorphologist should be consulted when a stream is reconstructed.

COMPANIONS: *Sediment Controls, Sediment Containments, Mulching, Vegetation, Slopes, Swales and Ditches, Cross Culverts, and Roads*

ENGINEERING SPECIFICATIONS

Any plan to install a structure or to perform any construction work within the waterway of a stream is subject to the rules and regulations of the U.S. Army Corps of Engineers for in-stream modifications (404 permits) and of the Maine DEP under the Natural Resources Protection Act. The Maine Department of Inland Fisheries and Wildlife should be consulted concerning fish passage and other useful information and guidance may be available from the Maine Forest Service.

CONSTRUCTION SPECIFICATIONS

- Live cuttings of willows and other fast growing woody plants (dogwood or poplar whips) can rapidly revegetate an embankment and provide greater stream strength than grasses. The material should be harvested during the dormant season, be healthy, at least one year old, be 1/2-inch thick and should be kept moist. Planting early in the spring will ensure successful growth.
- If trees need to be cut, leave their root system to hold the embankment; otherwise reduce the gradient of the slope to provide a stable condition for revegetation.
- Embankments that require riprap stabilization can be inter-planted with shrubs or. Place large riprap at the bottom of the embankment or combine with plantings.
- Wattles bundles (or fascine rolls) are harvested live branches placed parallel to the bank for stabilization. Anchor the wattle with 18-24 inch long live stakes (1 inch diameter or greater) leaving 2-3 buds above the ground surface. Compact the soil around the stakes and wattles to improve contact and retards moisture loss.
- Brush layering (8-12 inch thick layer of live cuttings) uses loose live cuttings interlayered with the soil to stabilize the bank. Proceed from the bottom upward and cover with fill or bank soil. The branches are set parallel to the direction of current or at an angle of 30-45° downward. Compact the soil over each layer and anchor with willow stakes. When newly re-established, the bank should be regularly checked and vegetation gaps replaced and mulched.
- Pesticides and fertilizers should not be used next to a stream.
- A new planting is rarely effective the first few years, should be mulched with erosion control mix or should be protected with riprap if within the flood elevation of the stream.

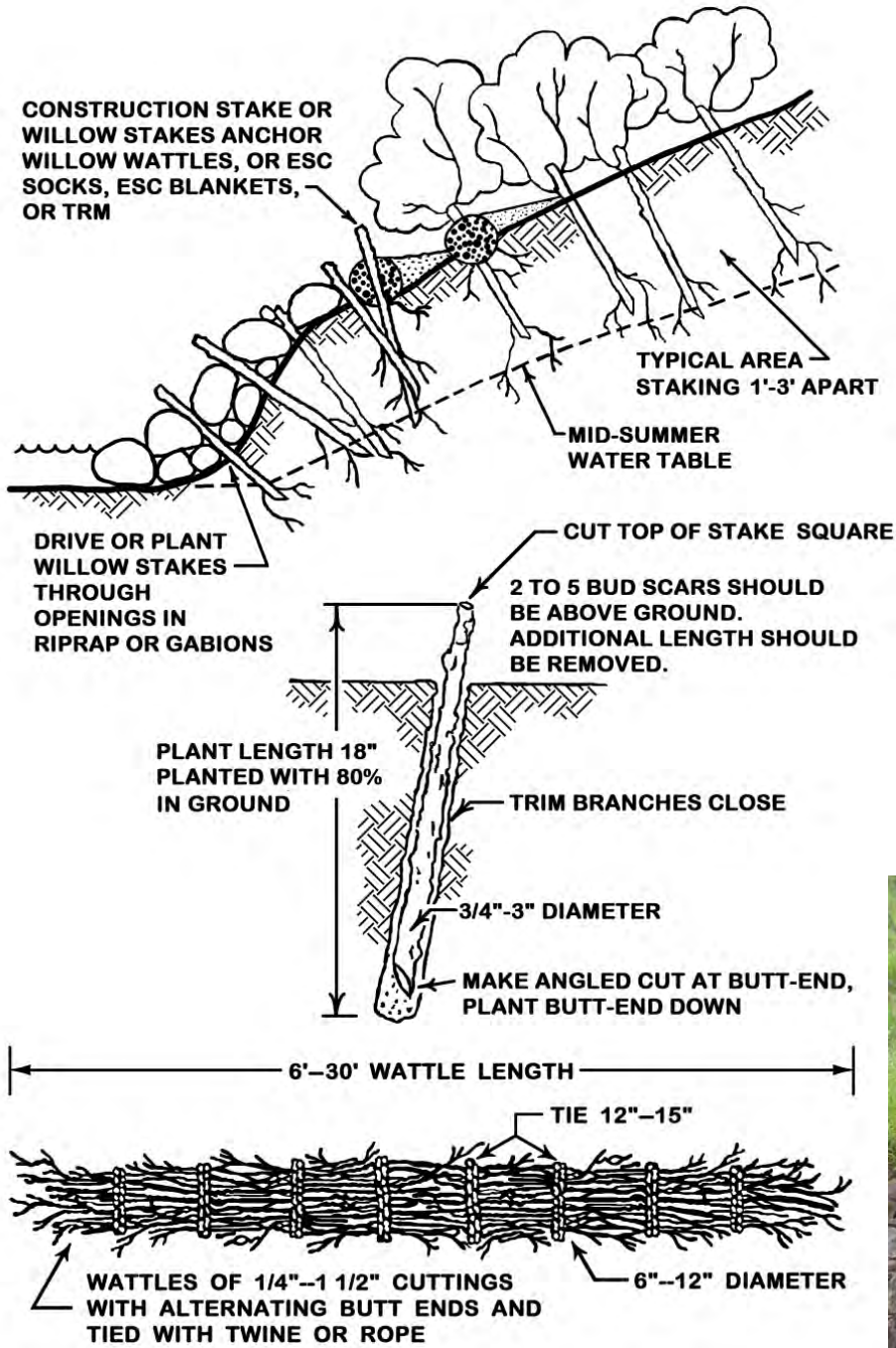

4. SAND DUNE AND TIDAL BANK RESTORATION

Coastal shorelines, sand dunes and tidal banks should be protected from erosion and storm surges with native cover. As the wind blows the sand off the beach and landward, salt tolerant plants trap most of the sand while continuing to grow, creating stable dunes that protect the coastline. Any work carried out on coastal shorelines will require approval under the Natural Resources Protection Act (NRPA) and the permit must be obtained prior to beginning work.

COMPANIONS: *Sediment Controls, Mulching, Vegetation, Slopes, Stream Crossings, Swales and Ditches.*

DUNE RESTORATION is a two-step process with reforming the dune —either by beach-scraping sand and grading it, or by sand-trapping— passively trapping sand carried onshore by wind or waves and replanting later. Restoring the beach by beach grading would allow immediate planting versus having to wait a season cycle for passive reconstruction.



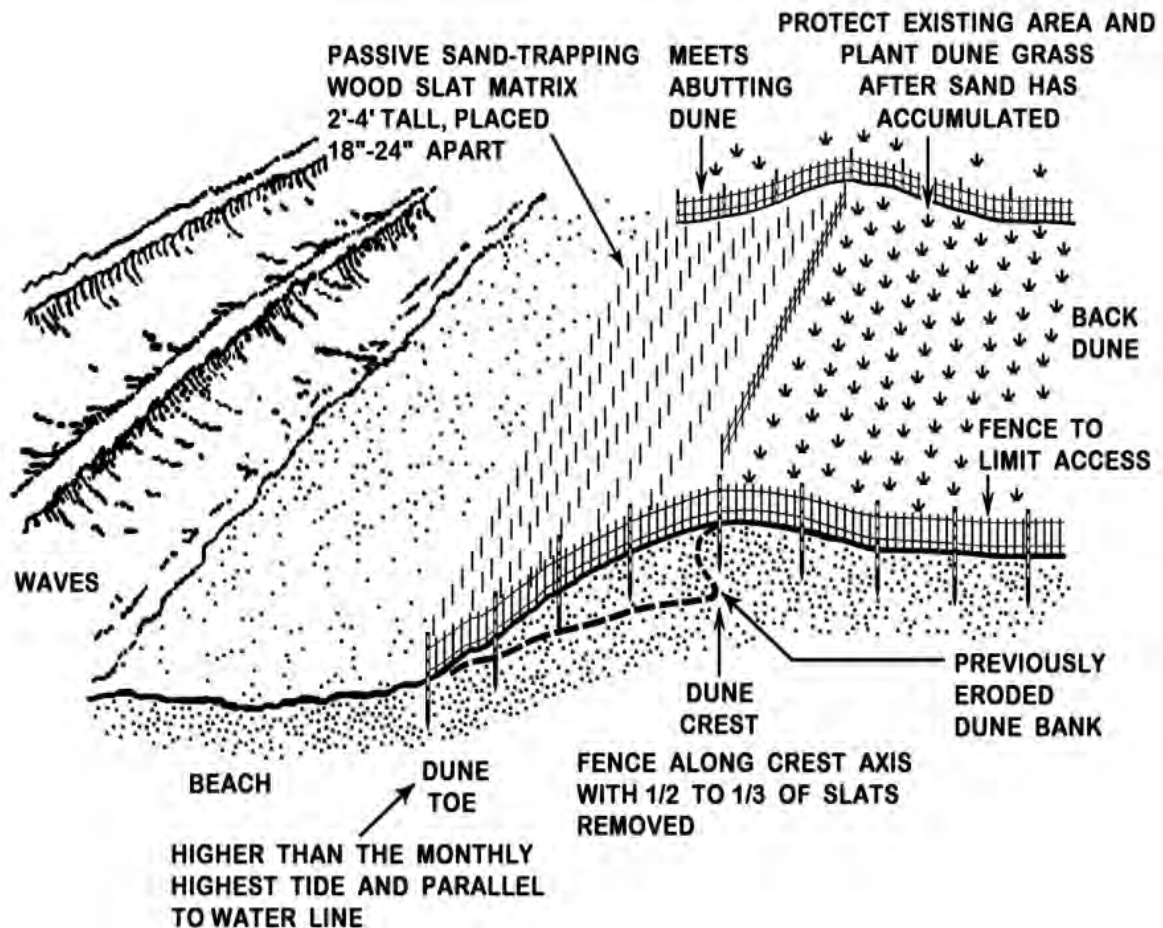
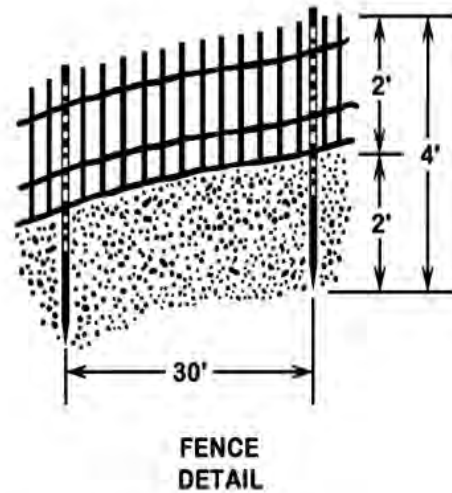
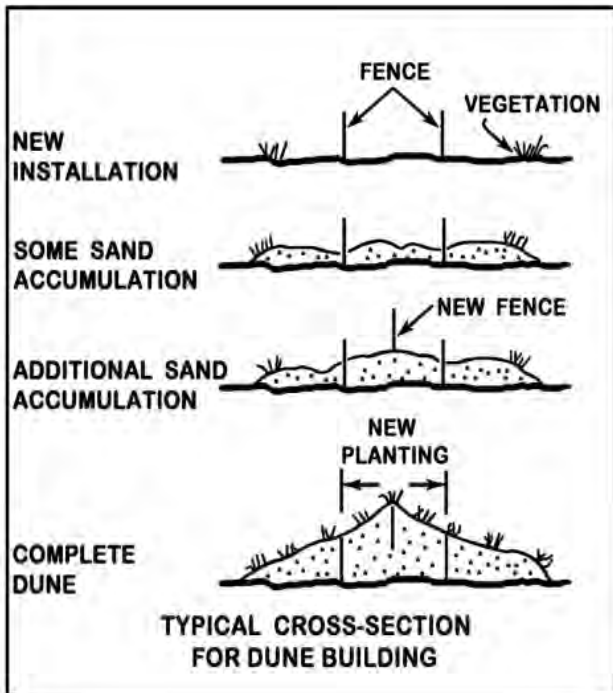

CONSTRUCTION SPECIFICATIONS - DUNE RECONSTRUCTION

- Maine has a narrow continental shelf, a limited sand budget, and short growing seasons. And dune reestablishment and stabilization may be a challenge without proper care and constant oversight.
- Dune stabilization should be located above the highest monthly high tide line, and should meet the adjacent dunes. As windblown sand moves from the beach landward, the beach grass traps the sand while continuing to grow through the additional accumulation. Frontal dune restoration should be no further seaward than any abutting dunes.
- Long stretches of frontal dune erosion can be repaired by restoring a sloped dune front and replanting. A sloped dune front or a low spot in a frontal dune can be restored by either beach-scraped sand, or passive-trapping of windborne sand. The slope needs to be less than 3:1.
- Good results have been experienced using 24-36 inch sand fence (4-foot fence cut in half) with half the slats removed to prevent a wind block, and installed in short sections (< 6 feet) to gradually accumulate sand and raise the dune elevation.
- The sections of fence are placed parallel to the shore or in a zig-zag pattern, using a rubber mallet to tap each slat into the sand. Alternatively, individual slats may be placed randomly with a 24-48 inch spacing to trap windborne sand.
- Sand-trapping wood slats and dune fencing need to be pulled up once sand has accumulated one half the height of the exposed slats, and reset to maximize their effectiveness.
- The wood matrix may get knocked out by a storm, and may require periodic maintenance and re-installation. Inspect the site periodically and after every major storm event.
- If the vegetation is lost from foot or vehicle traffic and from wind or water eroding the exposed sand; it can be repaired by sand-trapping and re-directing the access to the resource. Often, keeping foot traffic off the dune will allow the vegetation to re-colonize the damaged area and repair itself without intervention.
- Dune walkovers (elevated boardwalks over the dune) help conserve the dune by focusing foot traffic and preventing a footpath at grade that create a channel for storm waves to reach and damage the back dune area.
- A breach in a dune will cause a blow-out that will accelerate the sand loss from the back dune resource and should be quickly restored to a continuous line of vegetation to protect. The latter is known as an overwash fan for the fan-shaped pattern of sand and wrack that is deposited behind the dune crest. Dune restoration to repair a blow-out should be conducted by first filling the low spot and then restore a continuous line of vegetation.
- Restoring an eroded beachside may require many attempts before success.

PLANT SOURCES FOR DUNE REVEGETATION

Beach grass is sold as culms or stems, plugs, or potted plants. A culm is an intact grass stem that includes a basal node (they are sometimes sold as stems). A plug is a stem or culm that has been planted in a small amount of potting soil and has developed a network of fine roots and several above-ground shoots or stems. Culms can be harvested from productive natural or cultivated stands. Smooth and salt meadow cord-grass culms can be dug from an existing marsh. But the harvested plants should be taken from a widely dispersed, sandy area, rather than removed from a dense and mature mat. Cord-grass is ready for digging and transplanting when the top growth is 6-10 inches tall and has a well-developed root system. The following are the most common dune vegetation species. More options are provided in the following table.

- **Certified "Cape" American beach grass**, "Cape" strain (*Ammophila breviligulata*) is the best specie for stabilizing frontal dunes in Maine, where wind and storm waves occasionally expose the soil to salt spray. It can also be used for erosion control in non-dune areas that are occasionally exposed to high salinity. Beach grass should be planted above the zone of the highest monthly tides. Planting in the spring or fall is preferable to avoid drought conditions in mid-summer. Seaweed naturally fertilizes dunes and protects the vegetation against drought.
- **Smooth cord-grass** (*Spartina alterniflora*) is a long lived estuarine perennial that is the most productive marsh plant in regularly flooded intertidal zones along the Atlantic coast. Smooth cord-grass tolerates daily inundation by salt water and is planted between the mean low water line and the mean high water line. It can grow to seven feet tall with stems up to ½ inch in diameter.
- **Salt meadow cord-grass** (*Spartina patens*) grows in salt marshes and sandy meadows. It tolerates occasional flooding by salt water and occupies the drier zone immediately adjacent to the upper intertidal zone in protected embayments and estuaries. Mature plants are grayish green and grow up to 3 feet tall

CONSTRUCTION SPECIFICATIONS - DUNE REVEGETATION

- Frontal dune restoration should occur landward of the highest monthly tide line as dune vegetation cannot survive in zones that are routinely exposed to salt water from the highest monthly tides.
- Planting should occur between mid-spring and July 1st, or September 1st –October 31st.
- Plant vegetation in offset rows, parallel to the shoreline.
- The plants should be placed 18" on center (closer on sites with high erosion potential and wider in protected areas) and 8-10" deep in a hole that fully accommodates the plant roots, then secured by firmly pressing the soil around the roots.
- In poor soil, each planting hole should be provided with 1-2 oz. of slow release fertilizer.
- Protect the beach grass from vehicle and foot traffic with fencing. Dune walkovers or elevated boardwalks allow access to the beach and minimize erosion.
- Plantings should be monitored frequently. All woody debris washed onto the area should be removed; and failed plantings should be replaced. Seaweed should be left in place where it will fertilize the dunes as it decomposes and protect the dune soils and dune vegetation against drought stress and wind erosion
- New plantings can be fertilized in late May or June with 300-500 lbs. per acre of 10-10-10 fertilizer. Seaweed will naturally provide nutrients and organic material to the dune soils.

NATIVE PLANTS FOR COASTAL USES		
Plants for Frontal Dune Habitats		American Beach Grass (<i>Ammophila breviligulata</i>)
		Northern Bayberry (<i>Myrica pensylvanica</i>)
		Virginia Rose (<i>Rosa virginiana</i>)
		Beach Heather (<i>Hudsonia tomentosa</i>)
		Adam's Needle (<i>Yucca filamentosa</i>)
		Seaside dusty miller (<i>Artemisia stelleriana</i>)
		Beach Pea (<i>Lycopus maritima</i> , <i>L. japonica</i>)
		Beach Plum (<i>Prunus maritima</i>)
Trees & Shrubs for Back Dune Habitats	Upland, well-drained sites, tolerant of full sun	Staghorn sumac (<i>Rhus typhina</i>)
		Potentilla (<i>Potentilla fruticosa</i>)
		Northern Bayberry (<i>Myrica pensylvanica</i>)
		Ninebark (<i>Physocarpus opulifolius</i>)
		High bush cranberry (<i>Viburnum trilobum</i>)
		Sweet Fern (<i>Comptonia peregrina</i>) -- low shrub
		Fragrant Sumac (<i>Rhus odorata</i>) – low shrub
		Bush Honeysuckle (<i>Diervilla lonicera</i>) – low too
		White Birch (<i>Betula lenta</i>)
		Beach Plum (<i>Prunus maritima</i>)
		White pine (<i>Pinus strobus</i>)
		Hawthorne (<i>Crataegus crus-gulli</i> – only)
		Pitch Pine (<i>Pinus rigida</i>),
	Soils that do not dry out– stream corridors, sun & part shade	Birches: white birch, paper birch, yellow birch, river birch (<i>Betula spp.</i>)
		Shadbush/Serviceberry (<i>Amelanchia laevis</i>) –damp roots, full sun to part shade
		Winterberry (<i>Ilex verticillata</i>)—damp soils, full sun
		Flowering Raspberry (<i>Rhus odorata</i>)
		High Bush Cranberry (<i>Viburnum trilobum</i>) – plant singly, understory, mesic soils
		American Elder (<i>Sambucus canadensis</i>) – likes damp roots, full or part sun
		Dogwoods – flowering or pagoda (<i>Cornus alternifolia</i> , <i>florida</i>)
Sweetspire (<i>Itea virginica</i>)		
Herbaceous options:		Spiked Gayfeather (<i>Liatris spicata</i>)
		Butterfly weed (<i>Asclepias tuberosa</i>)
		Black-eyed Susans (<i>Rudbeckia hirta</i>)
		Yarrow (<i>Achillea millefolia</i>)
		New England Aster (<i>Aster novae-angliae</i>)
		New York Aster (<i>Aster novae-belgii</i>)
Underused Natives for other sites	Upland Sites	Tulip Tree, Catalpa Tree, Beech, Ironwood, Hop Hornbeam, American Filbert, American Hornbeam, Chestnut Oak, Sassafras, Linden, sheep laurel, mountain laurel, sweet gale.
	Damp soils / stream corridors	Swamp Tupelo (needs damp soils), Shagbark Hickory (river bottoms) sweet bay magnolia, cucumber magnolia, Pussy Willow (<i>Salix discolor</i>), Chokeberry, spicebush, sweet pepperbush (<i>Clethra</i>), fall blooming witch hazel, high bush blueberry (needs damp roots)
Invasive Species	remove and avoid planting	Bittersweet, knotweed, shrub honeysuckles, and autumn olive/Russian olive

Susanne Schaller, Bar Mills Ecological

GRASS ESTABLISHMENT FOR ESTUARINE SHORELINES
WITH TIDAL FLUCTUATION GREATER THAN 2.5 FEET

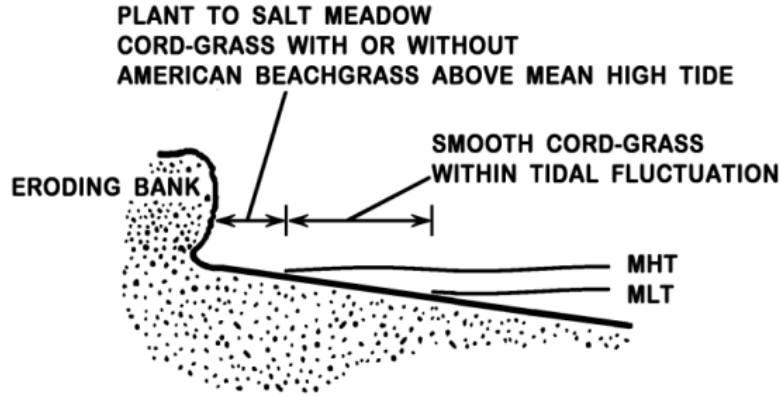

PLANTING MUST EXCEED 10 FEET
UNLESS SITE IS IN PROTECTED COVE

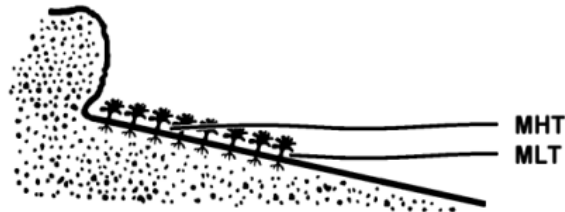

IMMEDIATELY AFTER PLANTING

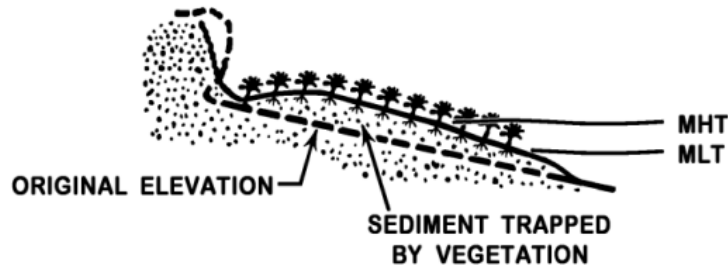

ANTICIPATED RESULTS

5. GRAVEL PIT RECLAMATION

Gravel pit reclamation of an inactive borrow area is the sloping back of the pit sidewalls and the application of vegetation to stabilize the soil from erosion (wind or water) to repair the aesthetic of the site and improve the area as a wildlife habitat. Sand and gravel pits are difficult sites to permanently establish vegetation due to the absence of topsoil.

COMPANIONS: *Sediment Controls, Sediment Containments, Mulching, Vegetation, Slopes, Roads, Swales and Ditches.*

CONSTRUCTION SPECIFICATIONS

- Construct a diversion at the top of long slopes to divert runoff away from the banks, and provide a slope drain (rock lined chute or equivalent) to direct the runoff to a stable outlet.
- Cut and fill slopes should not exceed 2.5:1 (refer to any DEP permit requirements) to maximize stability; and flatter slopes (3:1) are preferred for vegetation to establish.
- Remove stones, boulders, and other debris that will hinder the seeding process and establishment of vegetation.
- Spread a 4-inch layer of topsoil (minimum) and rototill to help root penetration into the less fertile subsoil, and to prevent slippage of the grass layer.
- Test the soil material from the upper 4 inches of the area to be seeded to determine lime and fertilizer needs and amend based on results.
- Select a grass/legume mixes recommended for gravel pits; they are better adapted and require little maintenance. Additional guidance on species substitutes and available seed sources may be obtained from NRCS field offices and local Soil and Water Conservation Districts.
- Seeding should occur as soon as the snow melts in the spring and no later than May 15 or failure can be expected.
- Substantial growth can be achieved if the site is fertilized again one year (between June 15 and July 15) after planting.
- Trees and shrubs can be planted on gravel pits as follow:
 - Bristly locust, sea-buckthorn, and common juniper are successful on sand and gravel soils.
 - Crabapples, red osier dogwood, high-bush cranberry, sumac species, thorn-apple, and mountain ash are effective as a wildlife food source.
 - Eastern red cedar, crabapples, European and Japanese larch, American arborvitae, red spruce, white spruce, Norway spruce, red pine and jack pine provide a good screening barrier.
- Avoid exotic invasive species such as autumn olive, Russian olive and Honeysuckle.
- Over-seeding shrub plantings with perennial ryegrass at 10 to 15 pounds per acre will provide protection against erosion while the shrubs are developing. Spacing of shrubs should be 4'x4' to 4'x6'.

APPENDIX A. EROSION AND SEDIMENT CONTROL LAWS

The following are a few of the State of Maine laws that are related to Erosion and Sediment Control. For additional information on these laws, please contact the nearest DEP regional office.

Erosion and Sediment Control Law (Title 38 M.R.S.A. Section 420-C) The Erosion and Sedimentation Control Law (Erosion Control Law) applies to all construction projects in organized territories that will cause the filling, displacement or exposure of all earthen materials. The Erosion Control Law requires that appropriate measures prevent unreasonable soil erosion and sedimentation beyond the site or into a protected natural resource (such as a river, stream, brook, lake, pond, or wetland). Erosion control measures must be installed before construction begins, and must be maintained until the site is permanently stabilized.

Natural Resources Protection Act (Title 38 M.R.S.A. Sections 480 A-JJ) The Natural Resources Protection Act (NRPA) regulates activities such as disturbing soil, placing fill, dredging, removing or displacing soil, sand or vegetation, draining or dewatering and building permanent structures in, on, over, and adjacent to lakes, ponds, river, streams, brooks, wetlands, coastal sand dunes, and tidal areas in organized territories.

Maine Construction General Permit Since 2003, certain construction activities in Maine require a Maine Construction General Permit (MCGP), based on the federal National Pollutant Discharge Elimination System (NPDES) Stormwater program that applies nationwide. The requirement for a MCGP is triggered by the amount of disturbed area created during construction, and whether the site will directly discharge to surface waters of the state. The MCGP applies only to construction activity and not to ongoing stormwater management following construction. The MCGP applies in both organized and unorganized areas of Maine.

Mandatory Shoreland Zoning Act (Title 38 M.R.S.A. Sections 435-438-B) The Mandatory Shoreland Zoning Act (MSZA) requires municipalities to adopt, administer, and enforce local ordinances that regulate land use activities in the shoreland zone. The shoreland zone is comprised of all land areas within 250 feet of:

- The normal high-water line of any great pond or river,
- The upland edge of a coastal wetland, including all areas affected by tidal action,
- The upland edge of defined freshwater wetlands; and
- All land areas within 75 feet of the normal high-water line of certain streams.

Stormwater Management Law (Title 38 M.R.S.A. Section 420-D) The Stormwater Management Law requires that a permit be obtained from the DEP for all projects that disturb more than one acre of land in organized territories of Maine. Proposed plans for stormwater management must be reviewed by the DEP before a new project is built.

Maine Land Use Planning Commission (Title 12 M.R.S.A. Section 681) and Development Review and Approval (Title 12 M.R.S.A. Sections 685-B, 685-B,1-A, B and B-1) The Land Use Planning Commission (LUPC) of the Maine Department of Agriculture, Conservation and Forestry has the authority to regulate land use activities located in the unorganized and de-organized areas of Maine that require a permit, or are allowed without a permit subject to standards under LUPC's Chapter 10 rules. Sections containing standards applicable to erosion control include, but are not limited to: Sections 10.25.K. Surface Water Quality, 10.25.M. Erosion and Sedimentation Control, 10.25.P. Protected Natural Resources, and Appendix B. Guidelines for Vegetative Stabilization. In the case of large scale developments triggering the DEP's Site Law in the unorganized territories, DEP is the primary permitting authority and LUPC certifies to the DEP that its Chapter 10 standards not covered under Site Law have been met.

Other Laws: Many construction activities will require other local, state or federal permits prior to beginning construction. Contact your local, state and federal agencies to determine what regulations apply to your project. For instance, you can contact:

- US Army Corps of Engineers for dredging, filling or building in or near wetlands and waterways.
- Department of Environmental Protection (DEP) for wetlands alteration.
- Code Enforcement Officer for the locality within which the project is proposed, including any shoreland zoning ordinances that need to be met.

APPENDIX B. MAINE DEPARTMENT OF TRANSPORTATION - STANDARD SPECIFICATIONS

The following table contains a list of some of the application standard specifications and materials to be used for erosion and sediment control. Contact the nearest MaineDOT office for further details.

MaineDOT Standard Specifications		
	SPECIFICATIONS	MATERIALS
Mulch	613 – Erosion Control Blankets 619 – Mulch	717.04 - Mulch 717.061 – Erosion Control Blankets
Erosion Control Mix Berms and Mulch		717.04(d) – Erosion Control Mix
Vegetation	615 – Loam 616 – Sodding 618 – Seeding 621 – Landscaping	717.01 - Fertilizer 717.03 – Seeding
Slopes, Cut and Fill	203 – Excavation and Embankment	
Geotextiles	620 – Geotextiles	722 – Geotextiles
Riprap	610 – Stone Fill, Riprap, Stone Blanket, and Stone Ditch Protection 620 – Geotextiles	703.26 – Plain and Hand Laid Riprap 703.27 – Stone Blanket 703.28 – Heavy Riprap
Culverts, Ditch Turnouts, Level Spreaders, Riprap Channels, Check Dams	610 – Stone Fill, Riprap, Stone Blanket, and Stone Ditch Protection	722.03 – Erosion Control Geotextile 703.29 – Stone Ditch Protection
Gravel Roads		703.10 – Aggregate for Untreated Surface Course and Leveling Course 703.06 – Aggregate for Base and Subbase 703.12– Aggregate for Crushed Stone Surface 703.20 – Gravel Borrow
French Drain, Inlet Protection	512 – French Drains	703.24 – Stone for French Drains
Gabions	601 – Gabions and Mattresses	711.02 – Gabions 711.03 – Stones for Gabions
Stream Crossing	510 – Special Detours	
Cofferdams	511 – Cofferdams	

APPENDIX C. HYDROLOGIC SOIL GROUPS AND SOIL INFORMATION

The following table provides information on the hydrologic soil series recognized in Maine and is current as of January 1, 2016. It is understood that these ratings may, and some probably will, change over time with better data. The US Department of Agriculture's Natural Resources Conservation Service should be contacted for more accurate information. <http://websoilsurvey.sc.egov.usda.gov/App/HomePage.htm>

It is important to point out that the USDA NRCS soil maps should be used for general planning purposes only as the maps' scale and accuracy are typically not sufficient for properly designing a development and planning for on-site erosion control measures. An on-site soil survey provided by a soil scientist should be performed to identify soil conditions, soil series, depth to groundwater and bedrock, non-stream water channels, and other features that might affect site engineering and constructability.

MAINE EROSION AND SEDIMENT CONTROL BMPs – 10/2016

SOIL NAME	K factor	SURFACE WATER PERMISSIBLE VELOCITY		WATERTABLE			DEPTH TO BEDROCK	HYDRIC SOIL	
	(10"-20")	BARE ft/sec	VEGETATED ft/sec.	INFLOW RATE cfs/1000 ft.	Kind	Depth in ft	Duration		inches
Hydrologic Group A									
Adams	0.17	2	4	1	----	>6	----	>60	N
Colton	0.17	2.5	4.5	1	----	>6	----	>60	N
Croghan	0.17	2	4	0.5	Apparent	1.5-2.0	Nov-May	>60	N
Danforth	0.28/0.15	2	3.5	0.15	----	>6	----	>60	N
Deerfield	0.17	2	4	0.5	Apparent	1.5-2.0	Nov-May	>60	N
Dune Land	0.10	2	4	1	----	----	----	----	----
Eldridge	0.32/0.49	1.5	3	0.05	Perched	1.5-3.0	Nov-May	>60	N
Enchanted	0.15/0.10	----	----	----	----	----	----	40-60	N
Hermon	0.10	2.5	4.5	1	----	>6	----	>60	N
Hinckley	0.17	2.5	4.5	1	----	>6	----	>60	N
Mahoosuc	0.05	----	----	----	----	>6	----	>60	N
Masardis	0.17/0.10	2.5	4.5	1	----	>6	----	>60	N
Merrimac	0.17/0.10	2.5	4.5	1	----	>6	----	>60	N
Pits, Gravelly	0.02	2.5	4.5	1	----	----	----	----	----
Pits, Sandy	0.15	2	4	1	----	----	----	----	----
Skowhegan	0.17	2	4	0.5	Apparent	1.5-2.0	Nov-May	>60	N
Stetson	0.17/0.10	2.5	4.5	1	----	>6	----	>60	N
Sunday	0.15	2.5	4.5	1	----	----	----	>60	N
Udipsamments	----	----	----	----	----	----	----	----	----
Windsor	0.17	2	4	1	----	>6	----	>60	N
Hydrologic Group A/D									
Au Gres	0.28/0.17	2	4	1	Apparent	0.5-1.5	Dec-May	>60	N
Bucksport	----	----	----	----	Apparent	+1-0.5	Sep-Jul	>60	Y
Chocorua	----	----	----	----	Apparent	+1-0.5	Jan-Dec	>60	Y
Kinsman	0.28/0.17	2	4	0.15	Apparent	0.5-1.5	Nov-May	>60	Y/N
Markey	----	----	----	----	----	----	----	----	----
Moosabec	----	----	----	----	----	----	----	----	----
Naskeag	0.1	2.5	4.5	0.15	Apparent	0.5-1.5	Nov-May	20-40	Y/N
Naumburg	0.28/0.17	2	4	0.15	Apparent	0.5-1.5	Dec-May	>60	N
Rifle	----	----	----	----	Apparent	+1-1	Nov-Jun	>60	Y
Scarboro	---/0.17	2.5	4.5	0.15	Apparent	+1-1	Sep-Jul	>60	Y
Searsport	---/0.17	2.5	4.5	0.15	Apparent	+1-1	Sep-Jul	>60	Y
Sebago	----	----	----	----	Apparent	+1-0.5	Sep-Jul	>60	Y
Togus	----	----	----	----	Apparent	+1-0.5	Sep-Jul	>60	Y
Vassalboro	----	----	----	----	Apparent	+1-0.5	Sep-Jul	>60	Y
Walpole	0.24/.10	2	4	0.15	Apparent	0-1.5	Nov-May	>60	Y/N
Waskish	----	----	----	----	Apparent	0-2	Nov-Jul	>60	Y

MAINE EROSION AND SEDIMENT CONTROL BMPs – 10/2016

SOIL NAME	K factor	SURFACE WATER PERMISSIBLE VELOCITY		WATERTABLE			DEPTH TO BEDROCK	HYDRIC SOIL	
	(10"-20")	BARE ft/sec	VEGETATED ft/sec.	INFLOW RATE cfs/1000 ft.	Kind	Depth in ft	Duration		inches
Hydrologic Group B									
Agawam	0.28/0.32	2	4.5	1	----	>6	----	>60	N
Allagash	0.28	1.5	3.5	1	----	>6	----	>60	N
Bangor	0.24/0.28	1.5	3	0.15	----	>6	----	>60	N
Berkshire	0.32	1.5	3	0.15	----	>6	----	>60	N
Caribou	0.24	1.5	3	0.1	----	>6	----	>60	N
Charlton	0.32	1.5	3	0.15	----	>6	----	>60	N
Fryeburg	0.32/0.49	1.5	3	0.1	----	>6	----	>60	N
Hadley	0.32/0.49	1.5	3	0.1	----	>6	----	>60	N
Hartland	0.49/0.64	1	2.5	0.1	----	>6	----	>60	N
Machias[^]	0.10	2.5	4.5	0.5	Apparent	1.5-2.5	Nov-Apr	>60	N
Madawaska[^]	0.28/0.17	1.5	3.5	0.5	Apparent	1.5-3.0	Nov-May	>60	N
Monadnock	0.28/0.17	1.5	3.5	0.15	----	>6	----	>60	N
Nicholville [^]	0.49/0.64/0.49	1	2.5	0.1	Perched	1.5-2.0	Nov-May	>60	N
Ondawa	0.20/0.37/0.20	2	4	0.2	----	>6	----	>60	N
Salmon (Hartland)	0.49/0.64	1	2.5	0.1	----	>6	----	>60	N
Sheepscot [^]	0.17/0.10	2.5	4.5	0.5	Apparent	1.5-2.5	Nov-May	>60	N
Hydrologic Group B/D									
Atherton	0.28	2	3.5	0.15	Apparent	0.5-0.5	Nov-Jun	>60	Y
Belgrade	0.49/0.64/0.49	1	2.5	0.1	Perched	1.5-2.0	Nov-May	>60	N
Charles	0.32/0.49	1.5	3	0.1	Apparent	0-1.0	Nov-Jun	>60	Y
Cornish	0.32/0.49	1.5	3	0.1	Apparent	1.0-2.0	Nov-May	>60	N
Elmwood+	0.32/0.49	1.5	3	0.05	Perched	1.5-3.0	Nov-May	>60	N
Fredon	0.28/0.10	2	3.5		Apparent	0-1.5	Oct-Jun	>60	Y/N
Halsey	0.24/0.10	2	3.5		Apparent	0-0.5	Sep-Jun	>60	Y
Limerick	0.32/0.49	1.5	3	0.1	Apparent	0-1.0	Nov-Jun	>60	Y
Lovewell+	0.32/0.49	1.5	3	0.1	Apparent	1.5-3.0	Nov-May	>60	N
Medomak	0.32/0.49	1.5	3	0.05	Apparent	+1-0.5	Sep-Jun	>60	Y
Ninigret+	0.28/0.17	1.5	3.5		Apparent	1.5-3.0	Nov-May	>60	N
Podunk+	0.24/0.37/0.20	1.5	3	0.15	Apparent	1.5-3.0	Nov-May	>60	N
Raynham	0.43/0.64	1	2.5	0.05	Apparent	0-1.5	Nov-May	>60	Y/N
Red Hook	0.32/0.17	2.5	4.5	0.15	Apparent	0.5-1.5	Dec-May	>60	N
Roundabout	0.43/0.64	1	2.5	0.05	Apparent	0-1.5	Nov-May	>60	Y/N
Rumney	0.28/0.37/0.28	1.5	3	0.15	Apparent	0-1.5	Nov-May	>60	Y/N
Saco	0.32/0.49	1.5	3	0.05	Apparent	+1-0.5	Sep-Jun	>60	Y
Scio+	0.49/0.64/0.49	1	2.5	0.1	Perched	1.5-2.0	Nov-May	>60	N
Sutton+	----	----	----	----	----	----	----	----	----
Swanton	0.28/0.32/0.49	1.5	3	0.05	Apparent	0-1.5	Nov-May	>60	Y/N
Whately	0.28/0.49	2	3.5	0.05	Apparent	+1-1.0	Oct-Aug	>60	Y
Winnooski+	0.32/0.49	1.5	3	0.1	Apparent	1.5-3.0	Nov-May	>60	N
Wonsqueak	----	----	----	----	Apparent	+1-0.5	Sep-Jul	>60	Y

MAINE EROSION AND SEDIMENT CONTROL BMPs – 10/2016

SOIL NAME	K factor	SURFACE WATER PERMISSIBLE VELOCITY		WATERTABLE			DEPTH TO BEDROCK	HYDRIC SOIL	
	(10"-20")	BARE ft/sec	VEGETATED ft/sec.	INFLOW RATE cfs/1000 ft.	Kind	Depth in ft	Duration		inches
Hydrologic Group C									
Becket	0.17	1.5	3	0.1	Perched	2.0-3.5	Mar-Apr	>60	N
Chesuncook*	0.24/0.32	1.5	3	0.1	Perched	1.5-3.0	Mar-May	>60	N
Conant	0.24	2	3.5	0.15	Apparent	1.0-2.5	Nov-May	>60	N
Dixfield*	0.20	2	3.5	0.1	Perched	1.5-2.5	Nov-Apr	>60	N
Elliottsville	0.24	1.5	3	----	----	----	----	20-40	N
Howland*	0.24	2	3.5	0.1	Perched	1.5-2.5	Oct-May	>60	N
Linneus	0.28	1.5	3	----	----	----	----	20-40	N
Mapleton	0.20	2	3.5	----	----	----	----	10-20	N
Marlow	0.24/0.32/0.20	2	4	0.1	Perched	2.0-3.5	Mar-Apr	>60	N
Melrose	0.32/0.49	2	4	0.1	----	>6	----	>60	N
Paxton	0.24/0.32/0.20	2	4	0.1	Perched	2.0-3.5	Mar-Apr	>60	N
Penquis	0.32	1.5	3	----	----	----	----	20-40	N
Perham*	0.24/0.32/0.37	1.5	3	0.1	Perched	1.5-2.5	Mar-May	>60	N
Peru*	0.24/0.32/0.37	1.5	3	0.1	Perched	1.5-2.5	Nov-May	>60	N
Plaisted	0.24	2	3.5	0.1	Perched	2.0-3.5	Nov-May	>60	N
Ragmuff*	----	----	----	----	----	----	----	----	----
Rawsonville	----	----	----	----	----	----	----	----	----
Sisk	0.28/0.32	----	----	----	----	>6	----	>60	N
Skerry**	0.20/0.28/0.17	1.5	3	0.1	Perched	1.5-2.5	Nov-May	>60	N
Suffield	0.32/0.49	1.5	3.5	0.05	Perched	1.5-3.0	Nov-May	>60	N
Surplus*	0.28/0.32	----	----	----	Perched	1.0-2.0	Oct-May	>60	N
Tunbridge	0.24/0.20	2	3.5	----	----	----	----	20-40	N
Winnecook	0.28	1.5	3	1	----	----	----	20-40	N
Hydrologic Group C/D									
Boothbay #	0.32/0.49	1.5	3	0.05	Apparent	1.0-2.0	Nov-May	>60	N
Buxton #	0.32/0.49	1.5	3.5	0.05	Perched	1.5-3.0	Nov-May	>60	N
Chesuncook**	0.24/0.32	1.5	3	0.1	Perched	1.5-3.0	Mar-May	>60	N
Dixfield**	0.20	2	3.5	0.1	Perched	1.5-2.5	Nov-Apr	>60	N
Dixmont	0.28	1.5	3	0.15	Perched	1.0-2.0	Nov-Jun	>60	N
Easton	0.24/0.37	1.5	3	0.1	Apparent	0-1.5	Oct-May	>60	Y/N
Howland**	0.24	2	3.5	0.1	Perched	1.5-2.5	Oct-May	>60	N
Lamoine	0.32/0.49	1.5	3	0.05	Perched	0.5-2.0	Nov-Jun	>60	N
Leicester	0.32	1.5	3	0.1	Perched	0-1.0	Nov-Jun	>60	Y
Perham**	0.24/0.32/0.37	1.5	3	0.1	Perched	1.5-2.5	Mar-May	>60	N
Peru**	0.24/0.32/0.37	1.5	3	0.1	Perched	1.5-2.5	Nov-May	>60	N
Pushaw	----	----	----	----	----	----	----	----	----
Ragmuff**	----	----	----	----	----	----	----	----	----
Skerry*	0.20/0.28/0.17	1.5	3	0.1	Perched	1.5-2.5	Nov-May	>60	N
Surplus**	0.28/0.32	----	----	----	Perched	1.0-2.0	Oct-May	>60	N
Washburn	0.24/0.37	2	3.5	0.1	Apparent	+1-0.5	Oct-Jul	>60	Y
Woodbridge	0.24/0.32/0.37	1.5	3	0.1	Perched	1.5-2.5	Nov-May	>60	N

MAINE EROSION AND SEDIMENT CONTROL BMPs – 10/2016

SOIL NAME	K factor	SURFACE WATER PERMISSIBLE VELOCITY				WATERTABLE		DEPTH TO BEDROCK	HYDRIC SOIL
	(10"-20")	BARE ft/sec	VEGETATED ft/sec.	INFLOW RATE cfs/1000 ft.	Kind	Depth in ft	Duration	inches	
Hydrologic Group D									
Abram	0.17	2	3.5	----	----	----	----	<10	N
Aurelie	0.17	2	3.5	0.1	Perched	0.0-1.0	Sep-Jun	>60	Y
Bemis	----	----	----	----	----	----	----	----	----
Benson	0.28/0.17	2	3.5	----	----	----	----	10-20	N
Biddeford	0.32/0.49	1.5	3	0.05	Apparent	+1-0.5	Oct-Jul	>60	Y
Brayton	0.32	1.5	3	0.1	Perched	0.0-1.0	Nov-Jun	>60	Y
Burnham	0.28	1.5	3	0.1	Apparent	+1-0.5	Oct-Jul	>60	Y
Cabot	----	----	----	----	----	----	----	----	----
Canaan	0.28/0.17	2	3.5	----	----	----	----	10-20	N
Canandaigua	0.49	1.5	3	0.05	----	----	----	----	----
Colonel	0.20	2	3.5	0.1	Perched	1.0-2.0	Oct-May	>60	N
Creasey	0.17/0.28	1.5	3	----	----	----	----	10-20	N
Daigle	0.24/0.37	1.5	3	0.1	Perched	0.5-1.5	Oct-Jun	>60	N
Gouldsboro	0.37	1.5	3	0.05	Apparent	+1-0.5	Jan-Dec	>60	Y
Hogback	----	----	----	----	----	----	----	----	----
Hollis	0.32	2	3.5	----	----	----	----	10-20	N
Knob Lock	----	----	----	----	----	----	----	----	----
Lyman	0.32	2	3.5	----	----	----	----	10-20	N
Monarda	0.28	2	3.5	0.1	Perched	0.0-1.0	Oct-Jun	>60	Y
Monson	0.24	2	3.5	----	----	----	----	10-20	N
Peacham	---/0.28	2	3.5	0.1	Apparent	+1-0.5	Oct-Jun	>60	Y
Pillsbury	----	----	----	----	----	----	----	----	----
Ricker	---/0.49	----	----	----	----	----	----	2-26	N
Ridgebury	0.32	1.5	3	0.1	Perched	0.0-1.0	Nov-Jun	>60	Y
Saddleback	0.28	----	----	----	----	----	----	10-25	N
Saugatuck	0.15	2	3.5	0.15	Perched	0.5-1.5	Dec-Jun	>60	N
Scantic	0.32/0.49	1.5	3.5	0.05	Perched	0.0-1.0	Oct-Jun	>60	Y
Schoodic	0.17	2	3.5	----	----	>6	----	2-10	N
Swanville	0.28/0.49	1.5	3	0.05	Apparent	0.0-1.0	Oct-May	>60	Y
Telos	0.28/0.32	1.5	3	0.1	Perched	0.5-1.5	Oct-Jun	>60	N
Thorndike	0.20	2	3.5	1	----	----	----	10-20	N
Westbury	0.32/0.24	1.5	3	0.1	Perched	0.5-1.5	Jan-Apr	>60	N
Whitman	---/0.28	2	3.5	0.1	Apparent	+1-0.5	Oct-Jun	>60	Y

Soils (with *) are HSG C or C/D depending on depth to Cd (C horizon with a dense unconsolidated material) and depth to water table - (with **) most commonly HSG C/D

Soils (with +) are HSG B or B/D if aquic-redox is within 60cm

Soils (with ^) are HSG B if water table is below 60cm and Ksat of lower horizon greater than 10

Soils (with #) are HSG C - or C/D if aquic-redox is within 60cm

APPENDIX D. INSPECTION CHECKLIST, FREQUENCY AND REPORTING FORM

Anyone who conducts or directs an activity that involves exposing, filling or displacing soil or other earthen materials should take appropriate measures to prevent erosion and the loss of sediment beyond the project site or into a sensitive resource. Erosion and sediment control measures should be in place before the activity begins and should remain functional until the site is permanently stabilized. All measures should remain effective until all areas are permanently stabilized.

Any disturbed area should be regularly inspected until the site is fully stabilized with either 90% grass cover or a permanent impervious surface such as pavement. A person who has the knowledge of erosion and sediment control measures and of stormwater management practices should inspect the site at a minimum once a week, and before and after a storm event. Any failing measure should be repaired or modified to adequately stabilize the site prior to the next storm event or no later than 7 calendar days.

The Inspection Frequency table found in in this appendix may be used and adapted as a guide for inspecting each specific practice. And the form may be used to record the inspection, its outcome and all needed maintenance tasks.

EROSION AND SEDIMENT CONTROL MEASURES AND ACTIVITY	INSPECTION FREQUENCY		
	Weekly	Before and After a Storm	After Construction
SEDIMENT BARRIERS			
Sediment barriers are installed prior to soil disturbances	X	X	
Silt fences are keyed in and tight	X	X	
Barriers are repaired and replaced as necessary	X	X	
Barriers are removed when the site is stabilized - Silt fence should be cut at the ground surface			X
TEMPORARY STABILIZATION			
Areas are stabilized if idle for 14 days or more	X	X	
Daily stabilization within 100 ft of a natural resource	X	X	
MULCH			
Seed and mulch within 7 days of final grading. Ground is not visible	X	X	
Erosion control mix is 4-6 inch thick	X	X	
Erosion control blankets or hay mulch are anchored	X	X	
VEGETATION			
Vegetation provides 90% soil cover	X		X
Loam or soil amendment were provided	X		X
New seeded areas are mulched and protected from vehicle, foot traffic and runoff	X	X	X
Areas that will remain unworked for more than 1 year are vegetated with grass	X		
SLOPES AND EMBANKMENTS			
Final graded slopes and embankments are stabilized	X	X	X
Diversions are provided for areas with rill erosion	X	X	X
Areas steeper than 2:1 are riprapped	X		
Stones are angular, durable and various in size	X		
Riprap is underlain with a gravel layer or filter fabric	X		
STORMWATER CHANNELS AND CULVERTS			
Ditches and swales are permanently stabilized—channels that will be riprapped have been over-excavated	X	X	X
Ditches are clear of obstructions, accumulated sediments or debris	X	X	X
Ditch lining/bottoms are free of erosion	X	X	X
Check dams are spaced correctly to slow flow velocity	X		
Underlying filter fabric or gravel is not visible	X	X	X
Culvert aprons and plunge pools are sized for expected flows volume and velocity	X		
Stones are angular, durable and various in size	X		
Culverts are sized to avoid upgradient flooding	X	X	
Culvert protection extends to the maximum flow elevation within the ditch	X	X	X
Culvert is embedded, not hanging	X	X	X

MAINE EROSION AND SEDIMENT CONTROL BMPs – 10/2016

CATCH BASIN SYSTEMS			
Catch basins are built properly	X		
Accumulated sediments and debris are removed from sump, grate and collection area		X	X
Floating debris and floating oils are removed from trap			X
ROADWAYS AND PARKING SURFACES			
The gravel pad at the construction entrance is clear from sediments	X	X	
Roads are crowned		X	X
Cross drainage (culvert) is provided	X		
False ditches (from winter sand) are graded		X	X
BUFFERS			
Buffers are free of erosion or concentrated flows		X	X
The downgradient of spreaders and turnouts is stable		X	X
Level spreaders are on the contour			X
The number of spreaders and ditch turnouts is adequate for flow distribution		X	X
Any sediment accumulation is removed from within spreader or turnouts		X	X
STORMWATER BASINS AND TRAPS			
Embankments are free of settlement, slope erosion, internal piping, and downstream swamping		X	X
All flow control structure or orifices are operational and clear of debris or sediments		X	X
Any pre-treatment structure that collects sediment or hydrocarbons is clean or maintained		X	X
Vegetated filters and infiltration basins have adequate grass growth			X
Any impoundment or forebay is free of sediment		X	X
WINTER CONSTRUCTION (November 1st-April 15th)			
Final graded areas are mulched daily at twice the normal rate with hay, and anchor (not on snow)	Daily		
A double row of sediment barrier is provided for all areas within 100 ft of a sensitive resource (use erosion control mix on frozen ground)	Daily		
Newly constructed ditches are rippapped	Daily		
Slopes greater than 8% are covered with an erosion control blanket or a 4-inch layer of erosion control mix	Daily		
HOUSEKEEPING PUNCH LIST			
All disturbed areas are permanently stabilized, and plantings are established (grass seeds have germinated with 90% vegetative cover)			X
All trash, sediments, debris or any solid waste have been removed from stormwater channels, catch basins, detention structures, discharge points, etc.			X
All ESC devices have been removed: (silt fence and posts, diversions and sediment structures, etc.)			X
All deliverables (certifications, survey information, as-built plans, reports, notice of termination (NOT), etc.) in accordance with all permit requirements have been submitted to town, Maine DEP, association, owner, etc.			X

CONSTRUCTION INSPECTION FORM FOR EROSION AND SEDIMENT CONTROL					
General Information:					
Site Name:	Date:	Inspected by:			
Owner:					
Retained 3PI:	Last Rain Date:	Amount:			
Reason for Inspection:	Weekly	Winter	Final	Rain Event	Complaint
Description of disturbed area:					
Photos:					
	YES/NO/NA	COMMENTS			
1. Is an Erosion and Sediment Control Plan available?					
ESC plan on-site and followed					
Other:					
2. Are all erosion control practices installed properly, maintained and functioning?					
Disturbed areas stable					
Concentrated flow inlet/outlet protection					
All areas at final grade					
Disturbed dormant areas stabilized					
Access roads and parking					
Hillsides and stockpiles					
Other:					
3. Are all sedimentation control practices installed properly, maintained and functioning?					
Construction entrance					
Sedimentation basins/traps/diversions					
Perimeter controls					
Check dams					
Other:					
4. Is maintenance of ESC measures, construction activities and housekeeping kept-up?					
Sedimentation/erosion in ditches					
Tracked Sediment or dust at exits					
Hazardous material storage and spill control practices					
Waste management (concrete, hazardous material, etc.)					
Other:					
5. Violation, Corrective Actions, Recommendations					
Sediment discharged from site?					
Corrective action required?					
Site compliant with all permits?					
Notice of violation or stop work order issued?					
Comments/Corrective Actions (complete corrective actions before the next rain event and within 7 day)					